

MiniPlex-S NMEA-0183 multiplexer Manual

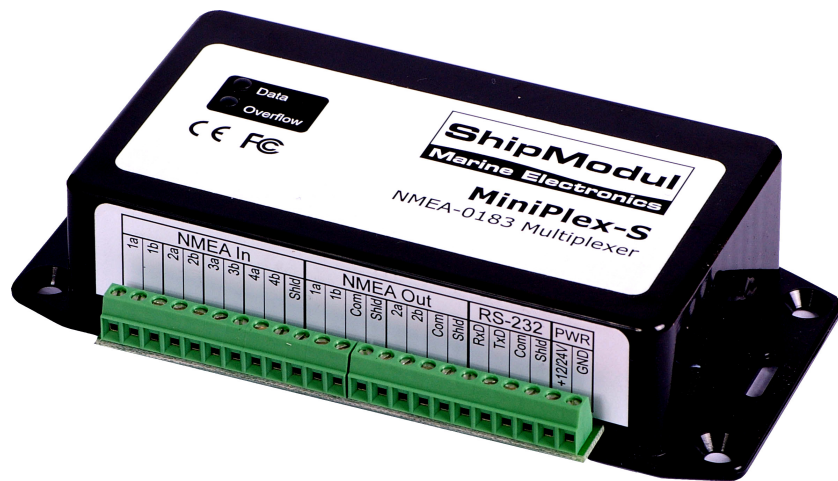

MiniPlex-S, V1.0
Firmware V2.9.0
Art.no.: 120

© CustomWare, 2008

Introduction

The MiniPlex-S is a four-channel NMEA multiplexer, enabling the connection of multiple NMEA-0183 instruments to each other and a computer. Available are four NMEA inputs (*listener*-ports), two NMEA outputs (*talker*-ports) and one RS-232 interface for connection with a computer. The multiplexer offers many features for manipulating incoming NMEA data like sentence filtering, real time mode, talker ID modification and SeaTalk to NMEA translation in order to read data from Raymarine instruments like the ST40, ST50 and ST60 series.

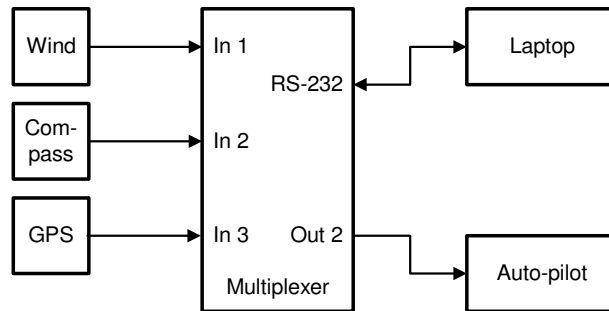

Operation

The multiplexer reads NMEA sentences from the listener ports and stores them in a buffer, one for each input. The sentences are read from the buffers in a round robin fashion - one sentence at a time - giving each listener port equal priority. Each sentence is then sent to the talker ports and the RS-232 interface.

The speed of the listener ports is fixed to 4800 Baud (= bits per second), which equals 480 characters per second. When all listener ports receive data at this rate, the buffers will not be emptied in time and an overflow situation occurs. The red LED indicates this situation. When a buffer is full, a partially received sentence will be discarded to ensure that the multiplexer only sends complete and valid NMEA sentences.

There are several ways to resolve this overflow situation:

1. Configure the instruments on the listener ports to send less data or with greater intervals. It is often possible to disable non-relevant sentences.
2. Many instruments do not allow selection of NMEA sentences to be output. In this case, use the NMEA sentence filter in the multiplexer to block unwanted sentences. Unwanted sentences are discarded immediately.
3. Set the operation mode of the multiplexer to Server mode (factory default). This mode only sends incoming data to the computer and to NMEA Out1, which is high speed. In Hub mode, the high-speed ports must wait for every character to be transmitted over the low speed NMEA Out 2 port.
4. Increase the speed of the RS-232/Out1 port on the multiplexer. The maximum speed is 38400 Baud. From 19200 Baud and up (4 x 4800!) an overflow will never occur, except when the multiplexer is set to Hub Mode.

The multiplexer has two talker ports, 'Out 1' and 'Out 2'. All received sentences from the listener ports are available on talker port 'Out 1'. Talker port 'Out 2' can be configured to output either all received sentences from the listener ports and the RS-232 interface (Hub Mode), or only sentences from the RS-232 interface (Server Mode). See the table below.

	NMEA In 1	NMEA In 2	NMEA In 3	NMEA In 4	RS-232 In
NMEA Out 1	H/S	H/S	H/S	H/S	-
NMEA Out 2	H	H	H	H	H/S
RS-232 Out	H/S	H/S	H/S	H/S	-

H: Hub mode, S: Server mode

Connections

NMEA Listener Ports

The multiplexer has four listener ports, 'In 1' to 'In 4'. Each listener port should be connected to one instrument only. These inputs are galvanically isolated from the multiplexer, as specified in the NMEA-0183 standard.

Connect the 'a' and 'b' terminals of the listener port on the multiplexer to the 'a' and 'b' terminals of the talker port on the instrument. Other designations used are for instance 'Data +' and 'Data -', 'TX+' and 'TX-', 'Out +' and 'Out -' or 've+' and 've-'.

Some instruments have single ended talker ports, with only one data terminal. Connect this terminal to the 'a' terminal on the multiplexer, and connect the 'b' terminal on the multiplexer with the ground of the instrument. The latter is often combined with the power supply ground.

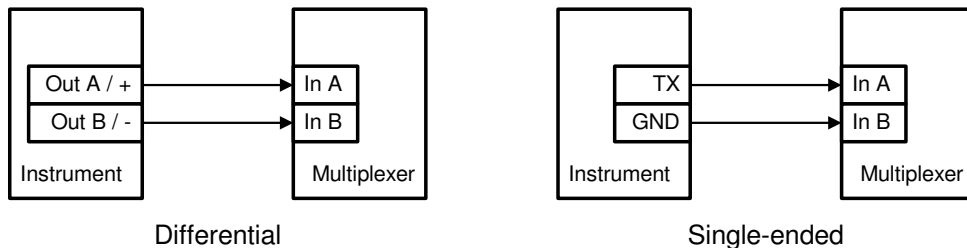

NMEA Talker Ports

Both talker ports can be connected to up to four instruments. Connect the 'a' and 'b' terminals of the talker port on the multiplexer to the 'a' and 'b' terminals of the listener port(s) on the instrument(s). Other designations used are for instance 'Data +' and 'Data -', 'TX+' and 'TX-', 'Out +' and 'Out -' or 've+' and 've-'.

Some instruments have single ended listener ports, with only one data terminal. Connect this terminal to the 'a' terminal on the multiplexer, and leave the 'b' terminal on the multiplexer unconnected. Connect the 'Com' terminal on the multiplexer with the instrument ground.

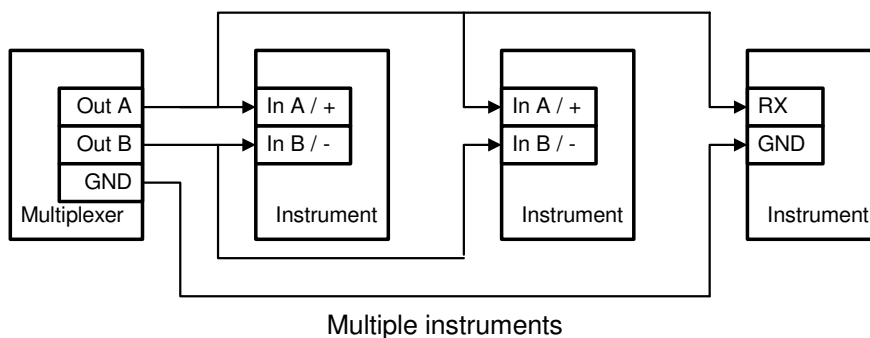
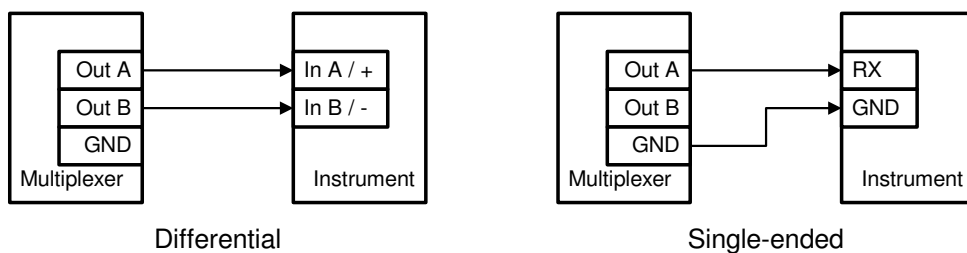

The shield terminals (Shld) can be connected to the screen/shield of the cable, if present. This should always be done on one end of the cable only, preferable on the talker side.

SeaTalk

SeaTalk® is a proprietary protocol developed by Raymarine®. This protocol is used for communication between Raymarine navigation instruments like the ST40, ST50 and ST60 series. To be able to use these instruments with commonly available navigation programs or to feed their data into other non-Raymarine instruments, the SeaTalk data needs to be translated into NMEA. Even Raymarine's own navigation software, Raytech Navigator, needs this translation.

The multiplexer can be connected to a SeaTalk network. It will translate all SeaTalk data required for navigation into NMEA sentences. NMEA Input 4 can be switched to SeaTalk mode and should be connected as follows:

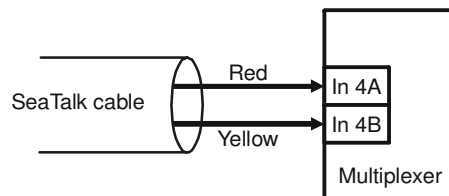

Connecting a SeaTalk network

The screen of the SeaTalk cable is not connected to the multiplexer.

RS-232 Serial Port

The RS-232 interface or serial port can be used to connect the multiplexer to a computer, as shown in the diagram below.

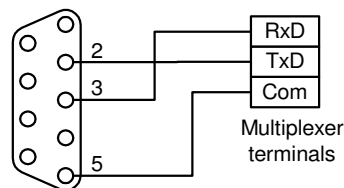

rear-view of
9-pin sub-D connector

The RS-232 interface is set to 4800 baud when shipped. It can however be set to any speed in the range from 4800 to 38400 baud using the MPX-Config utility.

Power Supply

The multiplexer operates from a DC supply voltage from 8 to 35V and is protected against reversed polarity. It is recommended to connect the multiplexer to the same power source or circuit breaker as the ships instruments and/or computer.

Configuration

Various options can be configured on the multiplexer, using the supplied configuration program MPX-Config. There is no installation procedure for this utility, just start it from the CD or copy it to a suitable folder on the hard disk of your computer. The top part of MPX-Config shows the NMEA sentences that are received by the multiplexer. The bottom part shows the configuration controls.

The File menu allows you to store the configuration settings of the multiplexer to a file or load the configuration from a file. This file format is similar to the Windows INI file format, allowing editing the files with a text editor. See the Technical Reference section for an example of a configuration file.

The multiplexer is configured with proprietary NMEA sentences. MPX-Config sends these sentences to the multiplexer but they can also be issued with a terminal program. See the Technical Reference section for a complete reference of the supported proprietary sentences.

All configuration settings are stored in the multiplexer's non-volatile memory. These settings are retained without power supply.

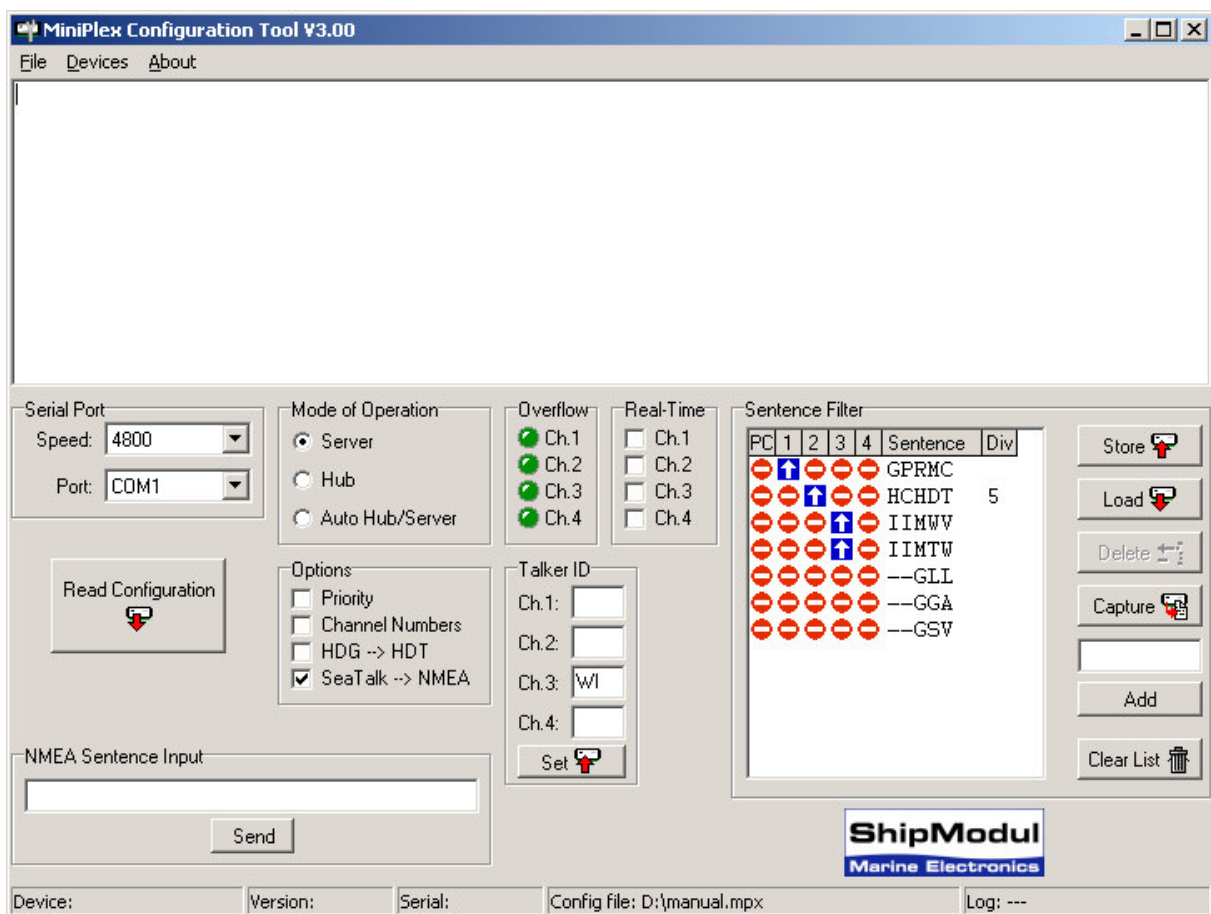

Screenshot of MPX-Config

Serial Port

Before being able to configure the multiplexer, select the serial port to which the multiplexer is connected. When selecting the baud rate, either choose 4800 (factory default) or choose 'Automatic' to let MPX-Config detect the communication speed of the multiplexer automatically. This may take a few seconds, especially when instruments are sending data to the multiplexer. When a 'Multiplexer does not respond' - message appears, disconnect or shut down the connected instruments. Another option is to try every possible setting from 4800 to 38400 baud, until NMEA data appears in the top window of MPX-Config. When the right baud rate has been found, the multiplexer will follow any change you make: when you set MPX-Config to 38400 baud, the multiplexer will also be set to this value in order to stay 'synchronized' with MPX-Config. If you exit

MPX-Config, the settings will be saved. Note that the Serial Port speed also affects the speed of NMEA Out1, since both ports run in parallel.

Read Configuration

Every time you start MPX-Config, it will request the current configuration from the multiplexer. When this is unsuccessful (various controls on the MPX-Config window are greyed), you can manually request the current configuration with this button.

The status line on the bottom of the MPX-Config window will show the name of the multiplexer, the internal software version, the serial number and the optionally loaded configuration file.

Options

Various options can be enabled on the multiplexer by checking one of the checkboxes as shown on the right.



Priority

The Priority option assigns a priority to incoming NMEA data, based on which input channel it is received. The RS-232 input has the highest priority, followed by NMEA In 1, 2, 3 and 4 in descending order. If for instance two GPS receivers are connected to input 1 and 2 and both GPS receivers output GPRMC sentences, only the sentence from the GPS on input 1 is passed. This feature can be useful to set up a second GPS as a backup for the main GPS.

The multiplexer only uses the sentence formatter (the 'RMC' part) for comparison. Another useful application is when a Loran-C receiver is used as a backup for the GPS. With the GPS connected to input 1 and the Loran-C receiver connected to input 2, the NMEA data from the GPS is passed while similar NMEA sentences (e.g. LCRMB, LCGLL) from the Loran-C are blocked. When the GPS fails, a timeout mechanism ensures that after 10 seconds the NMEA data from the Loran-C is passed through the multiplexer.

Please note that not every sentence from a lower priority input is blocked. When for instance the Loran-C outputs GLC sentences (which a GPS definitely does not), these are passed through the multiplexer too. The priority mechanism only works on sentences with a similar formatter (characters 3 to 5).

The following example shows what is passed and what not. The left column in the table shows the sentences from a GPS and the right column the sentences from a Loran-C. The sentences that are greyed in the table are blocked by the priority mechanism. The table shows that only the GLL and RMB sentences from the Loran-C are blocked. If it is necessary to block the remaining sentences from the Loran-C, the Sentence Filter can be used.

GPS (In 1)	Loran-C (In 2)
GPGLL	LCGLL
GPRMB	LCRMB
GPGGA	LCGLC
GPRMC	LCBOD

The priority mechanism can store up to 30 sentence types to determine their priority. The list is scanned every second and entries older than 10 seconds are removed. This ensures that sentence types on lower priority inputs are passed when their counterparts on higher priority inputs are no longer received.

Channel Numbers

This option inserts channel number information in the NMEA stream that is output by the multiplexer. Each NMEA sentence that is output on the RS-232 interface is preceded by a proprietary NMEA sentence '\$PSMDCN', to indicate on which NMEA input the following sentence was received. The following example shows that the IIGGA sentence was received on input 1, the GPGGA sentence on input 2, the IIGLL sentence on input 1 and the HEHDT sentence on input 3.

```
$PSMDCN,1*1A
$IIGGA,143357.999,5301.0061,N,00635.5479,E,1,06,1.9,90.0,M,,,,0000*2E
$PSMDCN,2*19
$GPGGA,143357.999,5301.0061,N,00635.5479,E,1,06,1.9,90.0,M,,,,0000*39
$PSMDCN,1*1A
$IIGLL,5301.0061,N,00635.5479,E,143357.999,A*22
$PSMDCN,3*18
$HEHDT,67.0,T*1E
```

This channel number information is used by our utility VirtualPlex-1 to send NMEA sentences from a certain input port on the multiplexer to a specific virtual serial port.

In the example on the right, VirtualPlex-1 is configured to create a virtual serial port COM3, which is assigned to input channel 2 on the multiplexer. Applications that open COM3 will thus only receive NMEA sentences from input channel 2 on the multiplexer.

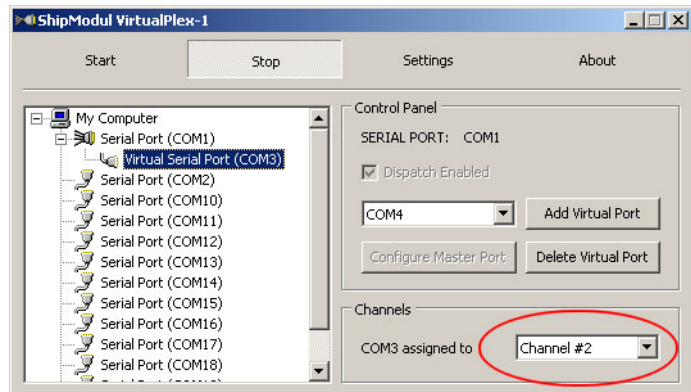

HDG -> HDT

This option changes an HDG sentence (magnetic heading) into an HDT sentence (true heading). If the HDG sentence contains a magnetic variation, it is used to calculate the true heading from the magnetic heading in the HDG sentence, otherwise the magnetic heading is just copied into the HDT sentence. This option can be used when a device like a Voyage Data Recorder needs a true heading from a gyrocompass while only a fluxgate compass is available.

SeaTalk -> NMEA

To enable translation of SeaTalk® into NMEA, check this option. SeaTalk is a proprietary protocol developed by Raymarine® and it is used for communication between Raymarine navigation instruments like the ST40, ST50 and ST60 series. To be able to use these instruments with commonly available navigation programs or to feed their data into other non-Raymarine instruments, the SeaTalk data needs to be translated into NMEA. See the Technical Reference section for an overview of the SeaTalk data that is translated into NMEA.

Mode of Operation

The multiplexer can operate in three different modes: Server, Hub and Automatic. Basically, these modes determine which NMEA data is available on NMEA Out2.

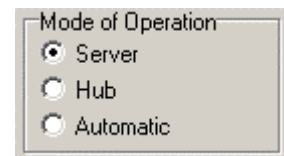

- Server mode: In this mode, the combination of computer and multiplexer acts as an NMEA server. Incoming NMEA data from NMEA In1 to In4 is sent to computer and NMEA Out1. NMEA Out2 only outputs data received from the computer.
- Hub mode: In Hub mode, the multiplexer acts as a hub where all NMEA data comes together and is sent out again. All incoming NMEA data from NMEA In1 to In4 and the computer is available on NMEA Out2. This mode has one limitation: since the NMEA data is sent to multiple outputs on the multiplexer, the total throughput is limited by the speed of the slowest output: NMEA Out2, which is fixed to 4800 baud. This may cause buffer overflows.
- Auto mode: When Auto mode is selected, the multiplexer automatically switches between Hub- and Server mode, depending on the presence of computer generated data. When the multiplexer receives NMEA data from the computer, it switches to Server mode. When no data is received from the computer for more than 10 seconds, the multiplexer will switch to Hub mode.

Auto mode is very useful when sailing alternately with or without a laptop. Consider a typical set-up as shown below:

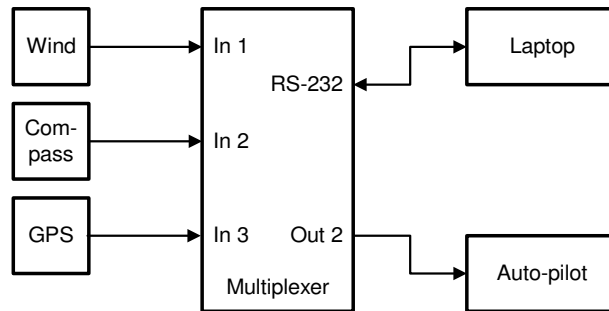

When the laptop is connected, it will receive all information from the instruments and the running navigation software is able to calculate the course to steer and drive the autopilot accordingly. Because the laptop is sending NMEA data, the multiplexer operates in server mode and the autopilot will therefore receive information from the laptop only.

When the laptop is not connected or the navigation software is not sending any data, the multiplexer switches to hub mode and sends all data from the instruments directly to the autopilot. This way, the autopilot will receive course information directly from the GPS.

NMEA Out1 is not affected by the mode setting. On this output, only NMEA data from the NMEA inputs is available. Since this output is connected in parallel with the RS-232 interface, it will operate at the same speed as the RS-232 interface. When the RS-232 interface is set to 38400 baud, NMEA Out1 will also run at 38400 baud.

Real-Time

The Real-Time option bypasses the buffer on a specific channel. In normal operation, all incoming NMEA sentences are stored in a buffer, one for each channel, which holds approximately 2 seconds of NMEA. In situations with heavy NMEA traffic, these buffers can be filled up quite rapidly until an overflow occurs (read LED blinks). Normally an overflow situation is not dangerous, it only means that every now and then an incoming NMEA sentence is discarded because the buffer has no room left to store the entire sentence.

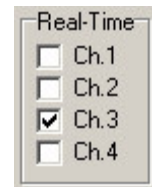

However, when a fluxgate or gyrocompass is connected, which sends its heading 10 or 20 times per second, the corresponding input buffer on the multiplexer is filled up constantly. Together with NMEA data from other instruments, the total amount of data passing through the multiplexer gets so high that almost all used inputs are in constant overflow, resulting in an unacceptable delay of information of up to 20 seconds. This makes it impossible for an autopilot to steer on a compass heading.

By enabling the Real-Time option on a channel that is connected to a compass, the buffer on that channel is bypassed and the NMEA data from the compass is passed through the multiplexer immediately. Some NMEA sentences will be discarded when the multiplexer is servicing another channel, but this is far less of a problem than having a 20 second delay in the heading information.

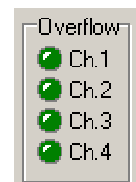

The overflow indicators on the MPX-Config screen can also be used to determine which channel is causing the overflow. The LED corresponding to the compass channel will be lit almost continuously. See the section **Operation** for ways to prevent an overflow.

Talker ID

The multiplexer allows you to change the talker ID of incoming sentences. Enter the desired talker ID in the edit box of the desired channel and press the Set button to send the setting to the multiplexer. Pressing the Read Configuration button will read the Talker ID settings from the multiplexer. To clear a talker ID, simply clear the edit box(es) and press the Set button. Please note that any combination of two characters can be used as talker ID, including spaces. Therefore, make sure you clear the edit box and not fill it with spaces if you want to clear a talker ID.

With the setting as shown on the right, any NMEA sentence received on input channel 1 will get talker ID 'II'. Thus a GPRMC sentence from a GPS will be changed into IIRMC.

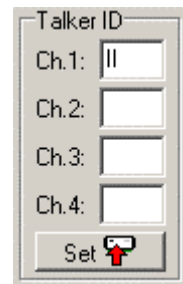

This feature can be useful when similar sensors are connected to the multiplexer and the software must be able to distinguish between the data from these sensors. A catamaran for instance could have a depth sensor in each hull, sending similar sentences to the navigation software.

Sentence Filter

The sentence filter is a powerful feature that allows you to specify exactly which NMEA sentence may be received on any channel, including the RS-232 interface. Up to 30 rules can be entered, either manually or by capturing the NMEA sentences received by the multiplexer.

Each filter rule consists of the address field of an NMEA sentence (2 characters for the talker ID and 3 characters for the sentence formatter like 'GPRMC') and an indicator for each channel (Inputs 1 to 4 and the PC). The indicator can be toggled between a pass sign (↑) and a block sign (↓) by clicking on it. This determines whether that specific sentence will be passed or blocked by the multiplexer. Wildcards are allowed too by using the '-' character.

An Example

The first step is to fill the list with NMEA sentences to be filtered. This can be done automatically by pressing the 'Capture' button. All controls will be disabled during capture and the 'Capture' button changes to 'Stop'.

Leave the capture mode running for approximately 10 seconds. By that time, all connected instruments will have sent NMEA sentences. Press 'Stop' to end capture mode.

To make sure all sentences are captured properly, no Talker ID's may be specified for input channels 1 to 4.

After the capture process, the list may look like the example on the right: the list shows received sentences GLL and RMC on input 1 and HEHDT on input 2 (GLL and RMC would have been preceded by GP but more on that later).

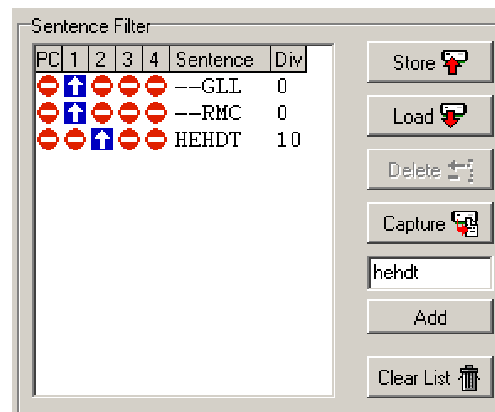

If for instance the GGA and GLL sentences have to be blocked, simply click on the pass signs of both sentences, to change them into a block sign. Pressing the Store button sends the list to the multiplexer. Now the filter is operational.

As can be seen in the picture, the GLL and RMC sentences contain two dashes ('--') to indicate a wildcard. This means that the first two characters are not used in the comparison with received data. In this case, the filter processes anything that has a sentence formatter of GLL or RMC. When a list is captured, you can click on a sentence with the cursor and edit the characters of that list entry. Thus a captured sequence with 'GPRMC' and 'GPGLL' can be changed into '--RMC' and '--GLL'. A useful purpose for wildcards is to block proprietary sentences from a device by entering 'P----' in the filter list. This will block any sentence that starts with a 'P'.

The number in the last column is a divisor factor. By default, this number is 0, which means that every occurrence of that sentence is passed. To lower the frequency of a sentence, a number between 2 and 99 can be entered. For instance, if a fluxgate compass is sending 10 sentences per second, and the multiplexer or a connected device is suffering from an overflow, you can enter a 5

in the divisor column. The effect is that every fifth sentence will be passed while all others are blocked. This brings the sentence frequency down from 10 to 2 sentences per second.

Managing the list

The filter list is managed in MPX-Config and can be stored to or retrieved from the multiplexer. Clicking on a traffic sign toggles it between a pass sign (🚦) and a block sign (🚫), which determines whether that specific sentence will be passed or blocked on that channel. Each column represents an input of the multiplexer, including the input from the computer (PC). The following management functions are available:

- Store** Stores the filter list from MPX-Config into the multiplexer. Any existing filter rules in the multiplexer are overwritten with the ones in the list.
- Load** Loads the filter list from the multiplexer into MPX-Config. The loaded filter rules are added to any existing rules in the list. If you do not want this, clear the list by pressing the Clear List button first.
- Delete** Delete a filter rule from the list in MPX-Config. Select the filter rule to be deleted by clicking on the formatter (e.g. 'RMC') and press the Delete button.
- Capture** Enables the capture mode. The filter list will be filled automatically with the NMEA sentences that are received by the multiplexer. For this function to work properly, it is necessary that any 'Talker ID' and 'Channel ID' settings be cleared first. Otherwise, the list will be filled with modified sentences instead of the originals.
- Add** Add a filter rule. Type the desired sentence address into the edit box left of the Add button and press Add or the enter key. This will enter a new filter rule with all channels blocked (🚫). The input is case-insensitive; every entered sentence formatter will be converted into uppercase. The input must contain 5 characters, including wildcards.
- Clear List** This button clears the filter list in MPX-Config (not the multiplexer!). To clear the list in the multiplexer, press the Store button after clearing the list in MPX-Config.

Manual NMEA input

MPX-Config allows manual entry of NMEA sentences for testing, configuration etc. Type the desired NMEA sentence in the edit box as shown on the right and press the Send button or the enter key. Do not precede the NMEA sentence with a '\$' as MPX-Config will do this for you. The input is case sensitive, so whatever you type will be sent literally to the multiplexer. Since all NMEA commands are uppercase, you have to enter them as uppercase.

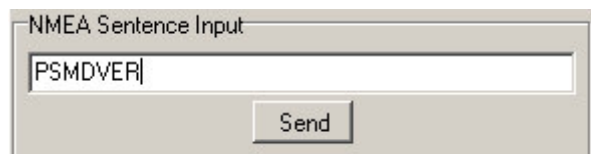

Indicators

The multiplexer has two LED's. The green LED indicates the reception of valid NMEA data on the listener ports or the Bluetooth interface. The LED only blinks on valid NMEA sentences that start with a '\$' or '!' and end with a LF character, thus indicating a proper connection and polarity of the connected instrument. In case of a reverse polarity, the green LED will not blink.

The red LED indicates a buffer overflow, in case more data is coming in than can be transmitted. See section "**Operation**" for options to resolve an overflow situation.

Both LED's will blink once when the power is applied to the multiplexer. When the red LED stays lit, a hardware error is found during execution of the self-test.

Mounting

The multiplexer is not waterproof. It should be mounted at a dry place, like behind the instrument panel, on a flat surface.

Technical Reference

MPX-Config Registry keys

The serial port settings of MPX-Config are stored in the Windows registry, using the following keys:

```
HKEY_CURRENT_USER\Software\CustomWare\MPXConfig\BaudRate  
HKEY_CURRENT_USER\Software\CustomWare\MPXConfig\SerialPort
```

MPX-Config INI file format

The configuration file format of MPX-Config resembles the standard Windows INI file format. Below is an example with has all possible options listed. The example corresponds with the settings shown on the MPX-Config screenshot on page 5.

```
[Configuration]  
Priority=0  
Channel Numbers=0  
HDG Translation=0  
SeaTalk=1  
Mode=0  
RealTime Ch.1=0  
RealTime Ch.2=0  
RealTime Ch.3=0  
RealTime Ch.4=0  
Talker ID1=  
Talker ID2=  
Talker ID3=WI  
Talker ID4=  
[Filter]  
GPRMC=01000,0  
HCHDT=00100,5  
IIMWV=00010,0  
IIMTW=00010,0  
--GLL=00000,0  
--GGA=00000,0  
--GSV=00000,0
```

Proprietary NMEA commands

The multiplexer supports some NMEA commands through proprietary NMEA sentences. They also generate certain proprietary NMEA sentences in some modes of operation or as a response to NMEA commands.

All commands have the following format:

\$PSMDxx

\$P: Start of a proprietary command. Dictated by the NMEA standard.
SMD: ShipModul manufacturer's mnemonic.
xx: Two- or three-character command code.

For ease of manual configuration, the commands issued to the multiplexer do not require a checksum. Sentences output by the multiplexer always contain a checksum. Sentences output by the multiplexer always contain a checksum, denoted with *hh in the descriptions below.

Command reference

VER – Get Version

Retrieves version information from the multiplexer. The multiplexer responds with the following version sentence:

\$PSMDVER,2.9.0,MiniPlex-S,10025943,8000*hh<CR><LF>

2.9.0: software version number
MiniPlex-S: product descriptor
10025943: serial number
8000: multiplexer capabilities. This is a 4 digit, 16-bit field represented as a hexadecimal number. Each bit identifies a capability of the multiplexer. The following bits are defined:
2-0: Interface type, 0 = serial, 1 = USB, 2 = Bluetooth
7: AIS mode supported (BT models only)
15: 3rd generation multiplexer

hh: checksum

CN - Channel Number indicator

This sentence precedes an NMEA sentence to indicate through which input channel the sentence was received.

\$PSMDCN,x*hh<CR><LF>

x: channel number 1,2,3 or 4.
hh: checksum

Example: \$PSMDCN,1*1A<CR><LF>

CF – Configuration

This sentence sets the configuration of the multiplexer. The same sentence is sent by the multiplexer in response to a CFQ sentence.

Command: \$PSMDCF,b,m,s,p,n,rrrr,h[*hh]<CR><LF>

b: baud rate selector: 0 = 4800 baud
1 = 9600 baud
2 = 19200 baud
3 = 38400 baud

m: mode selector: 0 = Server mode
1 = Hub mode
2 = Auto mode
3 = AIS mode (BT models only)

s: SeaTalk translation: 0 = off
1 = on
2 = dump all unknown SeaTalk datagrams as \$PSMDST,xx,xx,...
3 = dump all SeaTalk datagrams as \$PSMDST,xx,xx,...
4 = toggle generated wind sentence between VWR and MWV

p: Channel priority: 1 = on, 0 = off

n: Channel numbers: 1 = on, 0 = off

r: Real-time mode: 1 = on, 0 = off. Four digits, one digit per channel, numbered from 1 to 4

h: Heading translation: 1 = on, 0 = off

hh: optional checksum

When sending this command to the multiplexer, it is not necessary to specify every field when only one configuration parameter has to be changed. Fields preceding the one to be changed can be left blank. Fields after the one to be changed may be omitted. When for example only the channel priority must be changed, the command "\$PSMDCF,,,,1" may be sent. The fields 'b', 'm' and 's' are left blank while the fields for 'n', 'rrrr' and 'h' are omitted.

The 's' field will always return a 0 or 1 in response to a CFQ command.

CFQ – Request current configuration

This sentence requests the current configuration settings from the multiplexer.

\$PSMDCFQ<CR><LF>

The multiplexer responds with a CF sentence.

FL – Filter

This sentence specifies a filter rule that is applied on every incoming NMEA sentence. Sentences for which a rule is specified, will only be transferred if the input on which they are received matches the input specified in the filter rule.

Filter rules are specified by the formatter part of the NMEA address field, for instance the "RMC" part of a GPS "\$GPRMC" sentence. For each filter rule, the inputs to be passed can be specified. Sentences for which no rule exists are passed unrestricted.

\$PSMDFL,cccc,xxxxx,[dd][*hh]<CR><LF>

cccc: Sentence formatter of the filter rule (e.g. "GPRMC", "IIMWV", etc). This field may contain wildcard characters ('-'). For instance, "GP---" will apply to all sentences starting with "GP". Similarly, "--MWV" will apply to all sentences ending on "MWV" regardless of the talker ID.

- xxxxx: Inputs to pass. Each 'x' represents an input to assign to this rule, numbered from 0 to 4, where input 0 is the computer interface (serial or USB) and 1 to 4 represent NMEA inputs 1 to 4. A '1' means to pass, a '0' means to block. When all x'es are '1', the filter rule is removed.
- dd: Optional divisor factor (0..99). The frequency of a sentence is divided by this number to reduce the number of sentences over time. If for instance a divisor of 6 is specified for a sentence, only every 6th sentence is passed. This can be used to reduce the output of a high-speed heading sensor.
- hh: Optional checksum

A FL sentence without any parameters will erase all rules.

Example: \$PSMDFL,GPRMC,10011<CR><LF>

This sentence specifies a rule for all sentences that have the "GPRMC" sentence formatter. When this rule is applied, only "GPRMC" sentences on inputs 0 (the computer), 3 and 4 are transferred. An FL sentence with wildcards on all positions is discarded.

FLQ – Request filter list

This sentence requests the filter list from the multiplexer. The multiplexer responds by sending FL sentences, one for each list entry. An empty FL sentence denotes the end of the list.

Example:

```
$PSMDFL,GPRMC,10011,0*hh<CR><LF>
$PSMDFL,GPGGA,10001,0*hh<CR><LF>
$PSMDFL,--VWT,01000,5*hh<CR><LF>
$PSMDFL,GPGSV,00001*hh<CR><LF>
$PSMDFL,*hh<CR><LF>
```

The sentences may not be dumped as one contiguous block. In case of heavy NMEA traffic, they may be interspersed with other NMEA sentences.

ID – Talker ID

Enables a Talker ID to be set for a specific channel. If the talker ID is set for a specific channel, the original talker ID in the sentences received on that channel is replaced by the specified one, before sending the sentence to the computer.

\$PSMDID,aa,bb,cc,dd[*hh]<CR><LF>

- aa: Talker ID for channel 1
bb: Talker ID for channel 2
cc: Talker ID for channel 3
dd: Talker ID for channel 4
hh: optional checksum

An empty field clears the ID and disables the translation for that specific channel. Sending PSMDID without any fields clears all translations.

IDQ – Request talker ID's

Requests the Talker ID Translation settings. The multiplexer responds with an ID sentence.

OV – Overflow

In case of a buffer overflow (blinking red LED on the multiplexer), an overflow sentence is output, to indicate on which input buffer the overflow occurred:

\$PSMDOV,x<CR><LF>

x: Binary field. The first four bits indicate on which input buffer the overflow occurred.

Translated SeaTalk datagrams

When the SeaTalk translation is enabled, the following datagrams are translated into NMEA sentences:

SeaTalk	NMEA	Description
00	DBT	Depth below transducer
10	MWV	Wind angle, (10 and 11 combined)
11	MWV	Wind speed, (10 and 11 combined)
20	VHW	Speed through water
21	VLW	Trip mileage (21 and 22 combined)
22	VLW	Total mileage (21 and 22 combined)
23	MTW	Water temperature
25	VLW	Total and Trip mileage
26	VHW	Speed through water
27	MTW	Water temperature
50	---	Latitude, value stored
51	---	Longitude, value stored
52	---	Speed over ground, value stored
53	RMC	Course over ground. RMC sentence is generated from stored values from 5x datagrams.
54	---	GMT time, value stored
56	---	Date, value stored
58	---	Lat/Long, values stored
89	HDG	Magnetic heading, including variation (99)
99	---	Magnetic variation, value stored

As appears from the table, not all datagrams result in an NMEA sentence. Some datagrams are only used to retrieve a certain value to be combined into one NMEA sentence.

When the SeaTalk translation is enabled with option 2 (the 's' parameter in the CF sentence is 2), unlisted datagrams are translated into a proprietary NMEA sentence with the following format:

\$PSMDST,aa,bb,cc,dd...*hh<CR><LF>

aa,bb,cc,dd... represent the hexadecimal value of the bytes from the received SeaTalk datagram.

Technical Specifications

Supply voltage:	8 – 35 V _{DC} , protected against reversed polarity.
Current consumption:	40 mA (70 mA max. with fully loaded talker ports).
Inputs:	4 x NMEA-183/RS-422, galvanically isolated. 1 input can be set to SeaTalk mode.
Input resistance:	>800 Ohm.
Outputs:	1 x RS-232, 2 x NMEA-183/RS-422.
Buffers:	5 buffers of 800 characters (4 x NMEA, 1 x RS-232).
Filter list size:	30 sentence types
Priority list size:	30 sentence types
NMEA Out1:	Combined data from NMEA inputs.
NMEA Out2:	Combined data from NMEA and RS-232 inputs (Hub mode) or data from RS-232 input only (Server mode).
Speed NMEA In:	4800 Baud.
Speed NMEA Out1/RS-232:	4800-38400 Baud (NMEA HS).
Speed NMEA Out2:	4800 Baud.
Indicators:	Overflow and Data.
Dimensions:	138 x 72 x 33 mm.
Housing:	Flame retardant ABS.

Declaration of Conformity

We,

CustomWare
Borgstee 27b
9403 TS Assen
The Netherlands
Tel.: +31 592 375700
Fax: +31 592 375550

Declare under our sole responsibility that the product

ShipModul MiniPlex-S

to which this declaration relates is in conformity with the following specifications:

EN/IEC60945:2002 and EN/IEC61162-1:2000
FCC Title 47 CFR, Part 15 Class B

The product herewith complies with the requirements of the EMC Directive 89/336/EEC and carries the CE-marking accordingly.

Assen, 1-11-2008

M. Sprang

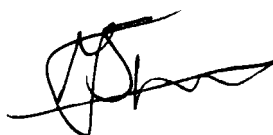

This device complies with Part 15 of the FCC Rules. Operation is subject to the following conditions:
(1) This device may not cause harmful interference, and (2) this device must accept any interference received, including interference that may cause undesired operation.



ShipModul / CustomWare
Borgstee 27b
9403 TS Assen
The Netherlands

Tel.: +31 592 375700
Fax: +31 592 375550

web: www.shipmodul.com
e-mail: mail@shipmodul.com