

MANUAL

MARINE CD/MP3/RECEIVER

MS-CD50

FUSION®

CONTENTS

- INSTALLATIONpg 3
- BUTTON DESCRIPTIONpg 6
- GENERAL OPERATIONpg 7
- MENU SELECTION FUNCTIONpg 8
- RADIO OPERATIONpg 8
- CD OPERATIONpg 9
- MP3 OPERATIONpg 10
- iPod® OPERATIONpg 11
- USB OPERATIONpg 12
- SUPPORTED MP3/WMA FORMATSpg 12
- TECHNICAL SPECIFICATIONSpg 14
- TUNERpg 14
- NOTESpg 15

RECORD YOUR PRODUCT DETAILS HERE:

MODEL NUMBER _____ DATE OF PURCHASE _____

AFFIX RECEIPT HERE

INSTALLATION

HEADUNIT INSTALLATION

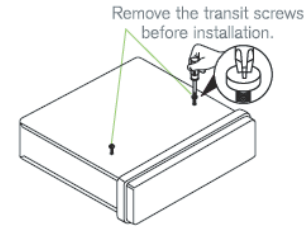

Before installing the unit, please remove the two transit screws.

Note: When installing this unit on a vessel, you must use the two pieces of plastic film(30mm x 20mm) supplied with the unit to seal the two holes after removing the screws, this will ensure the unit remains water resistant.

Mounting Hole Dimensions 178mmW x 178mmD x 50mmH

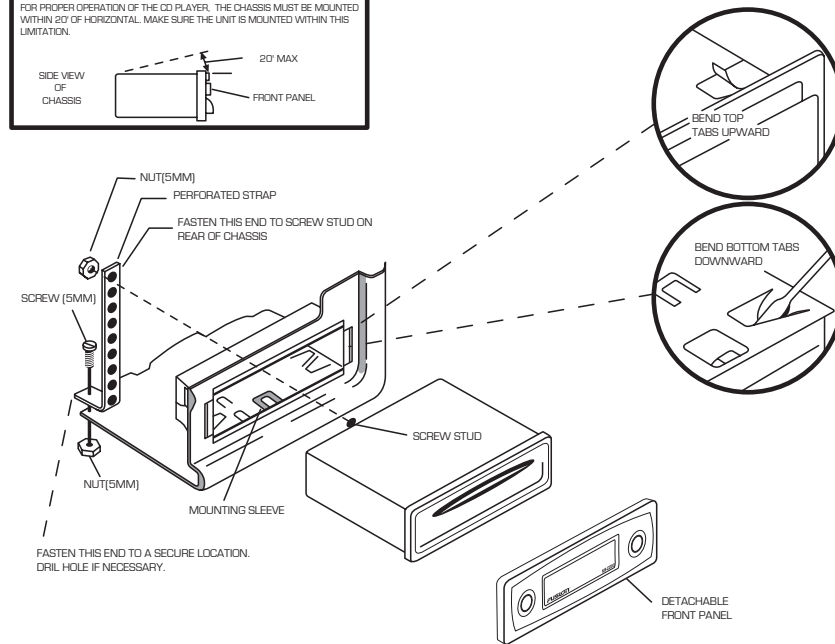
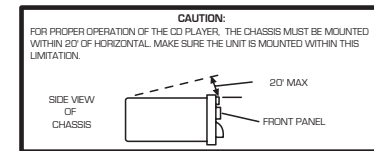

Insert the sleeve into the mounting hole and select the appropriate tabs to secure it firmly by bending them into position.

Use the supplied strap to support the rear of the unit.

REMOVING THE UNIT

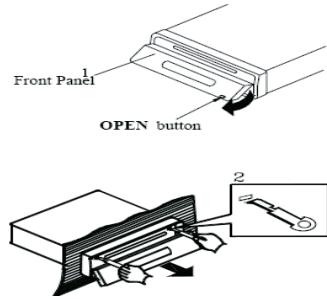

1. Press the open button on the face plate
2. Insert the supplied keys into the grooves in the housing until they click (as shown)
3. Pull the levers towards you and slowly remove the unit from the cage.

DETACHING FRONT PANEL

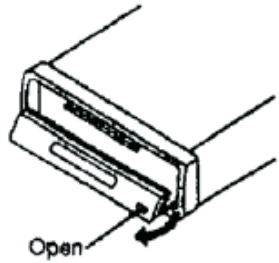

1. To detach the front panel press the open button
2. Then press the release button on the front underside edge and slide the face toward you.
3. A protective case is supplied to store your removeable front panel in.

REATTACHING FRONT PANEL

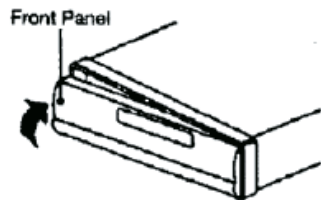

1. If the panel bracket is in the open position slide the panel back on into position.
2. If the panel bracket is in the upright position clip one end in firstly and then clip the other end in and the panel will lock in place.

WIRING CONNECTIONS

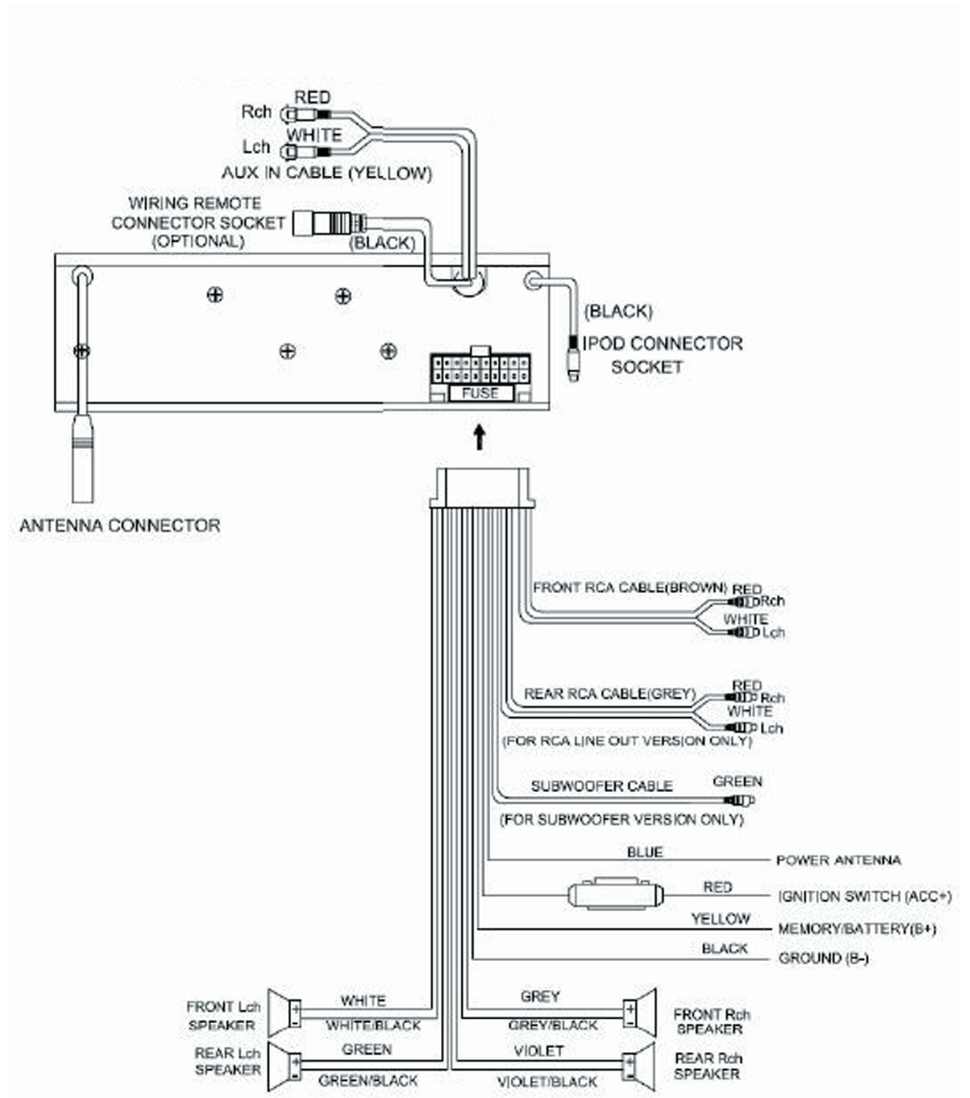

BUTTON DESCRIPTION

FRONT PANEL

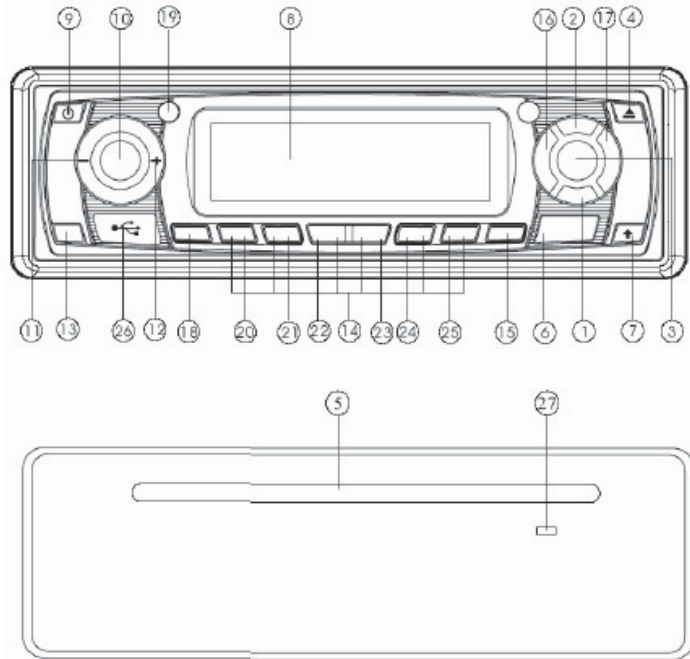

- | | |
|----------------------------------|------------------------|
| 1. MON -Mono/Stereo | 15. DISP |
| 2. AS/PS -Auto store preset scan | 16. ◀ (forward) |
| 3. ▶/ Mute | 17. ▶▶ (Rewind) |
| 4. ▲ (eject button) | 18. SCAN/IPOD-MENU/SCH |
| 5. Disc Slot | 19. EQ (equaliser) |
| 6. MODE/SUB.W | 20. DIR ^ (up) |
| 7. OPEN | 21. DIR v (down) |
| 8. Liquid Crystal Display | 22. RPT (repeat) |
| 9. ⏻/DIM | 23. SHF (shuffle) |
| 10. SEL/MENU | 24. SCN (scan) |
| 11. - (volume down button) | 25. Preset 6 |
| 12. + (volume up button) | 26. USB Interface |
| 13. BND/LOU/ENT | 27. Reset button |
| 14. Preset station buttons (1-6) | |

GENERAL OPERATION

POWER ON/OFF

Press the power ON/OFF button [9]

FRONT PANEL RELEASE

Press OPEN button [7] to open the front panel

SOUND ADJUSTMENT

Press the SEL/MENU button [10] repeatedly to cycle the audio mode through bass, treble, balance and fader modes. Press the VOLUME UP button [12] or VOLUME DOWN button [11] to adjust the selected mode.



SETTING THE CLOCK

Press and hold the DISPLAY Button [15] until the clock is displayed and flashes. Press the VOLUME UP button [12] to change the minutes and the VOLUME DOWN button [11] to change the hours. Press the DISPLAY button [15] to confirm and exit.

MUTE/PAUSE

In Radio/Aux mode, press PLAY/MUTE button [3] to mute the audio. Press again to resume.

LOUDNESS

Press and hold the BND/LOU/ENT button [13] to reinforce the bass output. Press again to cancel.

MODE SELECTION

Press the MODE button [6] to cycle through the source modes. Only active modes will be displayed. Eg. If there is no CD loaded CD mode will not be selectable.

SUBWOOFER LINE OUT

Press and hold MODE/USB/W button [19] to activate the Subwoofer output. Repeat to deactivate

EQUALIZATION

Press the EQ button [19] repeatedly to cycle through and select the EQ option you desire.

ESP

Electronic shock protection provides a 10 second read ahead buffer.

ILLUMINATION

Press and hold the POWER/DIM button [9] to adjust the LCD backlight brightness.

RESET BUTTON

The RESET button is located in the housing of the unit button [27] and must be activated with a ballpoint pen or something similar under the following conditions.

1. An error symbol is displayed
2. Function buttons do not operate correctly

FACTORY RESET

To reset the unit to factory settings and clear all programmed information press and hold the PLAY/PAUSE button (3).

MENU SELECTION FUNCTION

Press and hold SEL/MENU button (10) to enter Menu Select Mode. Press SEL/MENU (10) to cycle through menu and press the VOLUME UP button (12) or the VOLUME DOWN button (11) to adjust the function.

BEEP ON/OFF

Turn audible button beep ON/OFF

POWER ON VOLUME LEVEL

Set the default volume level when the unit is powered on

USA/EUR

Select USA or EUROPEAN Radio frequency stepping.

CLK ON/OFF

Select clock display ON/OFF when unit powered OFF.

PRI NO/SRC/CLK

Select Priority for display. No Priority, Source or Clock.

In PRI/CLK the clock will be displayed. Press DISPLAY button (1) the current source information will be displayed for a few seconds.

In PRI/SRC the current source information will be displayed. Press DISPLAY button (1) and the clock will be displayed for a few seconds.

In PRI/NO the relevant source information will be displayed, press the DISPLAY button (1) the clock will be displayed and will not change until the button is pressed again.

HOURS

Select 12/24 hour clock.

RADIO OPERATION

Press the MODE button (6) to select the Radio mode.

SELECTING FREQUENCY BAND

Press BND/LOU/ENT button (13) to cycle through and select the desired band



SELECTING STATION

Auto Seek

Press the REWIND button (16) or FAST FORWARD button (17) to activate the automatic seek function up or down the frequency spectrum.

Manual

Press and hold the REWIND button (16) or the FAST FORWARD button (17) until MANUAL appears on the screen. If neither button is pressed for several seconds the unit will switch to AUTO SEEK.

AUTOMATIC MEMORY STORING AND PRESET SCAN

Automatic Memory Storing

Press and hold the AS/PS button (2) and the unit will search for the strongest signals and then store them in the presets.

Preset Scan

Press the AS/PS button (2) to scan all stored preset stations.

STORING PRESET STATIONS

There are six presets available for each band (FM1, FM2, FM3, AM1 and AM2).

1. Select the desired band and tune in the station you want to store.
2. Press and hold the PRESET button (14) 1-6 until a beep is heard to confirm and the preset number is displayed.

MONO/STEREO

Press MON button (1) to select Mono or Stereo mode.

SCAN

Press SCAN/IPOD-MENU/SCH button (18) to scan stations and display frequency for several seconds.

CD OPERATION

If there is no CD loaded press OPEN Button (7) and gently insert the disc until you feel some resistance. The CD will be drawn into the unit and playback will begin.

If there is a CD already in the unit press the MODE button (6) until CD mode is displayed.

EJECTING A DISC

Press the OPEN button (7) and press the EJECT button (4).

PAUSE PLAY

Press PLAY/PAUSE/MUTE button (3) to pause play, press again to resume.

TRACK SELECTION

Press the REWIND button (16) to skip to the previous track or FORWARD Button (17) to skip to the next track.

Press and hold (17) to FAST FORWARD and (16) to FAST REWIND.

REPEAT TRACK

Press RPT button (22) to continuously repeat the track. Press again to cancel.

SHUFFLE

Press the SHF button [23] to play the tracks in a random order. Press again to Cancel.

SCAN TRACKS

Press SCN button [24] to play a few seconds of each track. Press again to cancel and continue playing the track.

MP3 OPERATION

TRACK SELECTION

Press the REWIND button [16] to skip to the previous track or FORWARD Button [17] to skip to the next track.

DIRECTORY SELECTION

Press DIR/DOWN button [20] or DIR/UP button [21] to navigate the directory.

DIRECT TRACK SEARCH

Press the SCAN button [18] once to enter the search mode then select the track number with the VOLUME +/- button [11 & 12] and confirm by pressing the BND/LOU/ENT button [13].

DIRECTORY OR FILE NAME SEARCH

Press the SCAN button [18] twice to enter the search mode. Characters are entered via the VOLUME +/- button [11 & 12]. Characters available are A-Z, 0-9, _, -, +. Enter the desired character and confirm with the SEL/MENU button [10] the cursor will move to the next digit. Once complete press the BND/LOU/ENT button [13] to begin search.

SEARCHING CURRENT DIRECTORY

Press the SCAN button [18] three times to enter the search mode. Use the VOLUME +/- buttons [11 & 12] to select the directory or file name displayed then press BND/LOU/ENT to play the selection.

PAUSE PLAY

Press PLAY/PAUSE/MUTE button [3] to pause MP3 play. Press to resume.

REPEAT SONG OR FOLDER

Press RPT button [22] to continuously repeat the current song. Press and hold RPT to repeat all songs in the current folder. Press again to cancel.

SHUFFLE

Press SHF button [23] to play all songs in random. Press and hold to select a folder and play contents of folder in random order. Press again to cancel.

PREVIEW ALL SONGS

Press SCN button [24] to play the first several seconds of each song. Press and hold to play the first several seconds of the first track in each folder. Press again during intro to play entire track.

DISPLAY INFORMATION

Press DISP button [15] to display the Clock, ID3 Tag (if available: Directory name, Song title, Artist name).

WMA OPERATION

Operation of discs recorded in this format is the same as MP3.

iPod® OPERATION

When an ipod is connected to the unit (via MS-IL50 Accessory cable) it will play automatically and IPOD will be displayed.

NB: Accessory MS-IL50 cable required for iPod connection. (not included)

IPOD MENU SEARCH

During playback press SCAN/IPOD-MENU button [18] to display menu. Press the REWIND button [16] or FAST FORWARD button [17] to navigate the menu and search by the following categories. PLAYLIST/ARTIST/ALBUM/GENRE/SONG/COMPOSER Press BND/LOU/ENT button [13] to enter the selected sub menu and search within the folder in the same manner pressing BND/LOU/ENT button [13] to confirm your selection.

DISPLAY

During playback press DISP button [13] to display current song information SONG TITLE/ARTIST/ALBUM NAME/CLOCK/TRACK/PLAY TIME.

PAUSE PLAY

Press PLAY/PAUSE/MUTE button [3] to pause play, press again to resume.

REPEAT TRACK

During playback press RPT button [22] and IPOD RPT will be displayed press again to cancel. RPT OFF will be displayed

RANDOM PLAY

During playback press SHF button [23] once the current selection has finished playing, all songs in the current category will play in a random order. Press again to cancel.

SCAN TRACKS

Press SCN button [24] to listen to the first few seconds of each track in the current selection IPOD SCN will be displayed, press again to cancel SCN OFF will be displayed.

TRACK SELECTION

During playback press FAST FORWARD button [17] to select the next track. Press REVERSE button [16] to play the previous track. If the song has been playing more than 1 second it will resume play from the beginning, if playing more than 2 seconds the previous song will be selected.

FAST FORWARD

Press and hold FAST FORWARD button [17] for 2 seconds to activate.

REWIND

Press and hold REWIND button [16] for 2 seconds to activate.

AUXILIARY INPUT

Connect an Auxiliary device to the RCA connectors on the rear of the unit. Press MODE button [6] to select AUX.

USB OPERATION

Connect the USB device via the USB interface (26) and playback of MP3/WMA files will start automatically. USB mode can be selected with the MODE button (6). Operation of the USB is identical to MP3 operation. (see page ?)

CAUTION: To safely eject the USB device ensure you change the mode to another source before removing the device.

NOTE: This product does not support all USB/MP3 players.

WARNING: Ensure when connecting an MP3 player via the USB interface that it has rechargeable batteries NOT standard batteries in use as this may cause the batteries to explode.

SUPPORTED MP3/WMA FORMATS

NOTES ON MP3 FILES

1. The disc must be in the ISO9660 level 1 or level 2 format.
2. When naming a MP3 file, be sure the file name extension is "MP3".
3. For a non-MP3 file, even though the file name extension is "MP3", the unit cannot recognise it.

1) MP3: Compliant with layer 3 of MPEG1/MPEG2/MPEG2.5

- Sampling rates (kHz): 48, 44.1, 32,
- Bit rates (kbps): 8, 16, 24, 32, 40, 48, 56, 64, 80, 96, 112, 128, 144, 160, 192, 224, 256, 320 variable bit rates supported.

2) WMA: Compliant with Windows Media Audio 9

- Sampling rates (kHz): 48, 44.1, 32
- Bit rates (kbps): 32 to 192 does not support DRM and Lossless, Professional and Voice of WMA9

	MP3/WMA	USB/SD
File	255 files / disc	255 files / folder
Folder	255 folders / disc	255 folders / device
Max File	255 files / disc	65025 files / device
Depth	8	8
		Support USB2.0 Full-speed

HANDLING COMPACT DISCS (CD/CD-R/CD-RW)

- Avoid touching the surface
- Avoid exposing the disc to direct sunlight
- Ensure the disc is clean
- Ensure the disc is not scratched or damaged.

PLAYBACK OF CD-R/CD-RW

- If your CR-R/CD-RW will not play. Ensure that the last recording session was closed or finalised.

SUPPORTED MEDIA

- Only use compact discs with the CD logo's on the label as listed below.



- If you use compact discs without the above logo's, correct performance cannot be guaranteed
- You can play audio discs recorded on CD-R (Recordable) and CD-RW (Re Writable) media

Windows Media and the Windows logo are trademarks, or registered trademarks of Microsoft Corporation in the United States and/or other countries.

Apple, the Apple logo, iPod and iTunes are Trademarks of Apple Computer, Inc, registered in the U.S. and other countries.

"MPEG Layer-3 audio coding technology licensed from Fraunhofer IIS and Thompson."

"Supply of this product only conveys a licence for private, non-commercial use and does not convey a licence nor imply any right to use this product in any commercial (i.e. revenue generation) real time broadcasting (terrestrial, satellite, cable and/or any other media), broadcasting/streaming via internet, intranets and/or other networks or in other electronic content distribution systems, such as pay-audio or audio-on-demand applications. An independent license for such use is required. For details, please visit <http://www.mp3licensing.com>"

FUSION[®]

Specifications and design are subject to change without notice