



Explorer 435/438





Fishfinder

Installation and Operation Manual

NORTHSTAR

www.northstarnav.com

IMPORTANT SAFETY INFORMATION
Please read carefully before installation and use.

	This is the safety alert symbol. It is used to alert you to potential personal injury hazards. Obey all safety messages that follow this symbol to avoid possible injury or death.
	WARNING indicates a potentially hazardous situation which, if not avoided, could result in death or serious injury.
	CAUTION indicates a potentially hazardous situation which, if not avoided, could result in minor or moderate injury.
	CAUTION used without the safety alert symbol indicates a potentially hazardous situation which, if not avoided, may result in property damage.

DISCLAIMER: It is the owner's sole responsibility to install and use the instrument and transducers in a manner that will not cause accidents, personal injury or property damage. The user of this product is solely responsible for observing safe boating practices.

BRUNSWICK NEW TECHNOLOGIES INC. AND ITS SUBSIDIARIES AND AFFILIATES DISCLAIM ALL LIABILITY FOR ANY USE OF THIS PRODUCT IN A WAY THAT MAY CAUSE ACCIDENTS, DAMAGE OR THAT MAY VIOLATE THE LAW.

Governing Language: This statement, any instruction manuals, user guides and other information relating to the product (Documentation) may be translated to, or

has been translated from, another language (Translation). In the event of any conflict between any Translation of the Documentation, the English language version of the Documentation will be the official version of the Documentation.

This manual represents the Explorer 435 and Explorer 438 as at the time of printing. Brunswick New Technologies Inc. and its subsidiaries and affiliates reserve the right to make changes to specifications without notice.

Copyright © 2006 Brunswick New Technologies Inc. Northstar™ is a registered trademark of Brunswick New Technologies Inc.

FCC Statement

Note: This equipment has been tested and found to comply with the limits for a Class B digital device, pursuant to Part 15 of the FCC Rules. These limits are designed to provide reasonable protection against harmful interference in a normal installation. This equipment generates, uses and can radiate radio frequency energy and, if not installed and used in accordance with the instructions, may cause harmful interference to radio communications. However, there is no guarantee that interference will not occur in a particular installation. If this equipment does cause harmful interference to radio or television reception, which can be determined by turning the equipment off and on, the user is encouraged to try to correct the interference by one or more of the following measures:

- Reorient or relocate the receiving antenna.
- Increase the separation between the equipment and receiver.
- Connect the equipment into an output on a circuit different from that to which the receiver is connected.
- Consult the dealer or an experienced technician for help.
- A shielded cable must be used when connecting a peripheral to the serial ports.

Contents

1 Introduction	6
1-1 Benefits of the Explorer 435 and Explorer 438.	6
1-2 How the Explorer 435 and Explorer 438 work	7
2 Basic Operation	8
3 Setting up the Explorer 435 and Explorer 438	10
3-1 Setup > System	11
3-2 Setup > Sonar	11
3-3 Setup > Fuel (<i>Explorer 438 only</i>)	12
3-4 Setup > Data	13
3-5 Setup > Logs	14
3-6 Setup > Alarms	14
3-7 Setup > Units	15
3-8 Setup > Comms (<i>Explorer 438 only</i>)	15
3-9 Setup > Calibrate	15
4 Using the Explorer 435 and Explorer 438	16
4-1 Interpreting the display.....	16
4-2 Fish detection and display	19
4-3 Gain	20
4-4 Range	21
5 The Displays	21
5-1 Sonar display	22
5-2 Sonar Zoom display	22
5-3 Sonar Bottom display.....	22
5-4 Sonar A-Scope display	23
5-5 Fuel display (<i>Explorer 438 only</i>).....	23
5-6 Data display	24
6 Installation and Maintenance	24
6-1 What comes with this product?	24
6-2 Options and Accessories	24
6-3 Mounting and removing the display unit	24
6-4 Wiring Options	25
6-5 Systems of several instruments	26
6-6 Cleaning and maintenance	27

Important

It is your sole responsibility to install and use Northstar's instrument & transducers in a manner that will not cause accidents, personal injury or property damage. Always observe safe boating practices.

The choice, location, angle and installation of the instrument & transducers are critical to performance of the system as intended. Follow instructions in this manual carefully. If in doubt, consult your Northstar dealer.

Ensure that any holes cut are in a safe position and will not weaken the boat's structure. If in doubt, consult a qualified boat builder.

Do not install plastic through hull transducers in solid wooden hulls. Leaking through the hull may result.

Do not install bronze transducers in metal hulls. This will cause electrolytic corrosion that may result in damage to the hull or transducer.

Sonar Performance: The accuracy of the sonar depth display can be affected by many factors, including the type and location of the transducer and water conditions. Ensure that the transducer is located and used correctly.

Fuel Computer: Do not rely on the fuel computer as the sole source of information regarding available fuel onboard. Fuel economy can change drastically depending on boat loading and sea conditions. Fuel Computer information should be supplemented by visual or other checks of the fuel load. This is necessary due to possible operator errors such as forgetting to reset the fuel used when filling the tank, running the engine with the Fuel Computer not switched on, or on other operator actions that may render the device inaccurate. Always carry adequate fuel onboard for the intended trip, plus a reserve to allow for unforeseen circumstances.

Failure to adhere to these warnings may lead to death, serious injury or property damage. Northstar disclaims all liability for installation or use of this product that causes or contributes to death, injury or property damage or that violates any law.

As Northstar is continuously improving this product we retain the right to make changes to the product at any time which may not be reflected in this version of manual. Please contact your nearest Northstar office if you require any further assistance.

The Explorer 435 and Explorer 438 are set up with default units of feet, °F (Fahrenheit), US gallons and knots. See section 3-7 Setup > Units, to change the units.

1 Introduction

Congratulations on choosing a Northstar fishfinder. For maximum benefit, please read this manual carefully before installation and use.

This manual describes how to install and set up the Explorer 435 or Explorer 438. Refer to separate Transducer Installation Instructions supplied with the transducer.

1-1 Benefits of the Explorer 435 and Explorer 438

The Explorer 435 and Explorer 438 are high quality fishfinders that are supplied with a transducer. Both use TFT (Thin Film Transistor) technology to provide a color display for easy daylight viewing. The LED backlight can be dimmed for night fishing. The bracket mounting option also allows the fishfinder to be tilted and swivelled for optimum viewing.

The colors on the sonar displays are customizable, with a choice of four 16 color palettes and one 8 color palette. The colors represent different signal strengths, making the sonar displays easy to interpret.

This capability, combined with a variable power output of up to 200 W RMS, ensures that the Explorer 435 and Explorer 438 operate effectively in shallow and deep water.

The Explorer 435 and Explorer 438 can detect the bottom to a depth of 600 feet (180 metres) depending on the clarity of the water and the type of transducer used.

The Northstar fishfinder can be used to find fish, to locate features on the bottom such as reefs or wrecks and to help recognize favourite fishing spots from the bottom profile.

The Northstar fishfinder can also assist with navigation by providing depth information to

This manual also explains how to operate the Explorer 435 and Explorer 438 effectively and gives troubleshooting and performance tips.

Important

It is vital to the performance of the fishfinder that the transducer is installed in the best location. Please follow the installation instructions very carefully.

CAUTION

IMPORTANT NOTE ON USE. While any fishfinder can be used as an aid to navigation, accuracy can be limited by many factors, including the location of the transducer. It is the user's responsibility to ensure the Northstar fishfinder is installed and used correctly.

help identify the depth contours marked on charts.

With the optional fuel kit, the Explorer 438 also becomes a sophisticated and easy-to-use fuel computer.

All of the Northstar 400 Series fishfinders use proprietary SBN Technology for sonar processing to improve Signal enhancement, Bottom recognition and Noise rejection.

SBN Technology uses digital adaptive filter algorithms to enhance all returned signals. At the same time, SBN Technology uses active noise control to reject interference, which can often be mistaken by fishfinders for true returns.

Using SBN Technology, the fishfinder analyses the reflections from each pulse, filters false returns and displays what is in the water under the boat. See section 4-1 Interpreting the display, for more information.

1-2 How the Explorer 435 and Explorer 438 work

The Explorer 435 and Explorer 438 have two parts:

- the transducer attached to the hull
- the display unit.

The transducer generates an ultrasonic pulse (sound that is above the hearing range of the human ear), which travels down towards the bottom at a speed of about 4800 ft/sec (1500 m/sec), spreading out into a cone shape.

When the pulse meets an object, such as a fish or the bottom, it is partly reflected back up towards the boat as an echo. The depth of the object or bottom is calculated by the Explorer 435 and Explorer 438 by measuring the time taken between sending a pulse and receiving the echo. When an echo has been returned, the next pulse is sent.

The Explorer 435 and Explorer 438 convert each echo into an electronic signal, displayed as a vertical line of pixels. The most recent echo appears on the extreme right of the display, with the older echoes being scrolled towards the left, eventually disappearing off the display.

The scroll speed depends upon the water depth and scroll speed setting. See section 3-2 Setup > Sonar and section 4-1 Interpreting the display, for more information.

The appearance of echoes displayed are affected by:

- the fishfinder settings (range and gain settings)
- echoes (different fish types, different bottom types, wrecks and seaweed)
- noise (water clarity and bubbles).

See section 4-1 Interpreting the display, for more information.

2 Basic Operation



Key Names

- < Returns to the previous menu / zooms in.
- ^, v Cursor keys move the selection highlight and change settings / scrolls up or down.
- > Confirms changes / zooms out.

MENU Press to show the Display menu
Press again to show the Setup menu.

+ Increases the Range. } Hold for Auto Range
- Decreases the Range. }

⏻ Press and hold to power On and Off; pressing once shows the Gain controls. Press twice to show Backlight control.

Key Operation

The fishfinder is operated through menus.

To select a menu item:

1. Press ^ or v to move the highlight to the item.
2. Press > to select the item.

To change a setting:

1. Use the cursor keys ^ or v to make the change(s).
2. Press > to confirm; < to cancel.

Power On / Auto Power

Press **⏻** to turn the fishfinder on.

If the fishfinder is wired for auto power, it turns on automatically whenever the boat's ignition

is turned on. This ensures that the engine hours counter and optional fuel functions are activated. *A title display appears briefly. This is followed automatically by the Installation menu **only the first time the fishfinder is switched on.** Use this menu to specify the language (see section 3-1 Setup > System) and units (see section 3-7 Setup > Units).*

At all other times, the title display is followed by the display that was used most recently.

If the transducer is not connected, the message: **No transducer detected. Enter simulate mode?** will appear. Press ^ or v to select and press > to accept. (If the transducer was not intentionally disconnected, turn off the fishfinder and refer to the section on Troubleshooting in Appendix B.)

Power Off

To turn the fishfinder off, hold **⏻**. A countdown box appears. Continue to hold **⏻** for 3 seconds until the fishfinder turns off.

Note: If the unit is wired for Auto Power (section 6-4 Wiring options) the fishfinder can be turned off only when the boat's ignition is turned off.

Simulate Mode

An internal simulator allows users to learn how to operate the fishfinder off the water.

In Simulate mode the word **Simulate** flashes at the bottom of the display. The fishfinder generates data so that all the main displays appear to be operational.



Use Setup > Simulate as follows:

1. Press **MENU** twice to show the Setup menu.
2. Highlight Simulate.
3. Press > to select On or Off.

Gain Adjustment

Gain (sensitivity) controls the amount of detail displayed on the screen. Refer to section 4-3 for more information.

1. Press **⏻** briefly to show the gain controls.
2. Press **∧** or **∨** to adjust gain.
3. Press > to switch between auto and manual gain.
4. Press < or **MENU** to confirm and exit.

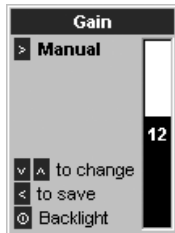

Display Adjustment

The display and keys are backlit, with a choice of 16 brightness levels. To change the backlight level:

1. Press **⏻** twice to show the backlight control.
2. Press **∨** to dim or **∧** to brighten.
3. Press > to confirm.



3 Setting up the Explorer 435 and Explorer 438

Press **MENU** twice to show the Setup menu, then select a particular option using the \wedge or \vee cursor keys. (Section 2 Basic Operation, describes how to use the keys in more detail.)

The Setup menu and options are summarized below. **The factory default settings are shown where applicable.** Each Setup menu option is explained in the following sections.

The Setup menu and options

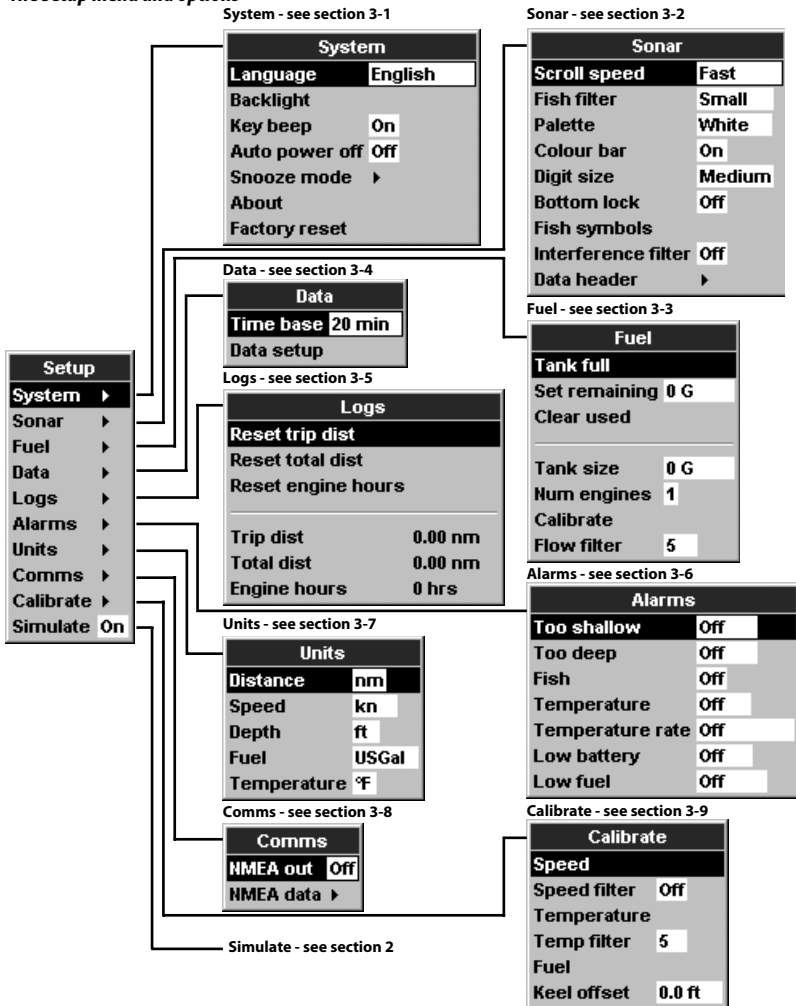

3-1 Setup > System

Press **MENU** twice to display the Setup menu, then select System:

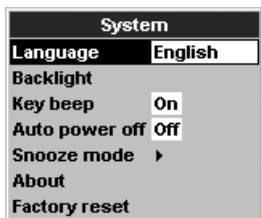

Language

Select the language for the displays. The options are: English, Italian, French, German, Spanish, Dutch, Swedish, Portuguese, Finnish and Greek.

Tip: In case you can't read the current language, the language setting is found at the top of the system menu.

Backlight

The backlight control is displayed. The bar setting represents the current level of backlighting.



Key beep

Enables or disables the beep when a key is pressed.

3-2 Setup > Sonar

Press **MENU** twice to display the Setup menu, then select Sonar:

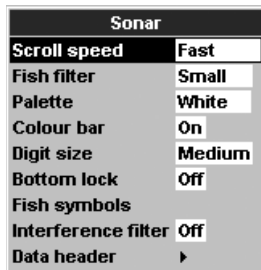

Auto power off

Select On to have the fishfinder power off automatically every time the boat's ignition is switched off. This applies only if the display unit is wired for Auto Power. See section 6-4 Wiring Options.

Snooze Mode

This power saving option slows the sounding rate (time between each ultrasonic pulse) to a user specified interval from 5 minutes to 2 hours. The fishfinder appears to turn off, however all alarms operate normally. To return to normal operation, press any button. Ideal to be used as an anchor alarm.

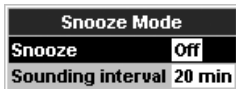

Factory reset

This option returns all of the fishfinder settings (except the language) to the default factory settings shown in section 3 Setting up the Explorer 435 and Explorer 438.

"Reset to factory defaults?" appears. Press > select Yes or No. Then press **MENU** or < to reset and exit.

Scroll speed

Use this to set the scroll speed on the display. There is a choice of: Very Fast, Fast, Medium, Slow and Pause. The depth of the water also affects the speed of the display.

Faster scroll speeds combined with a slow boat speed (typically between 2 and 6 knots) shows the most fish detail. Medium or Slow scroll speeds result in sonar information being displayed over a longer period, but with less detail. See Section 4-1 Interpreting the display, for more information.

Fish filter

Use this to select the minimum fish symbol size to be detected and displayed. There is a choice of: Small, Medium and Large.

Palette

Use this to select a color palette. Each color within the palette represents a different echo strength, as shown on the sonar displays.

There is a choice of five color palettes: **Black**, **Blue**, **White**, **Vivid** and **8 color**. The first four display more detail, whilst the **8 color** palette shows a greater distinction of signal strength between each adjacent color. For the 16 color palette, each color covers 1.5 dB signal range. For the 8 color palette, each color covers 3 dB signal range.

Color bar

This shows the range of colors used for the selected color palette.

It can be switched **On** or **Off**. If switched **On**, it is displayed down the left hand side of all the sonar displays.

Digit size

Use this to change the size of the depth display on the sonar displays. There is a choice of: **Small**, **Medium** and **Large**.

Bottom lock

If **Bottom lock** is **On**, the zoom section moves so the bottom is always displayed in the zoom section, regardless of changes in depth.

If **Bottom lock** is **Off**, the bottom will not be displayed in the zoom section when it is outside the range covered by the zoom bar.

Using the **Bottom Lock** and the **A-Scope** features together can be a powerful aid in recognising the type of bottom.

Fish symbols

These appear only in the main sonar displays. Fish symbols can be shown in three ways:

- As a fish symbol (**On**).
- As a fish symbol with the depth (**On+depth**). The depth is shown beside the fish symbol.
- Switched off (**Off**) so that echoes are not converted to fish symbols but are displayed directly.

See section 4-2 Fish detection and display, for more information about fish symbols.

Interference filter

This filters the echo signal to reduce high-level, spiky interference, such as engine noise.

It can be switched **On** or **Off**.

Data header

The data header can be turned **On** or **Off**.

When **On**, it is a customizable feature that can be used to display up to 6 data items, such as boat speed or fuel used.

To customize the size of the Data header, highlight **Size** and press **>**. There is a choice of **Small** and **Large**.

To customize the data items to be displayed:

1. Highlight **Data setup** and press **>**. The Data header increases in size to display all 6 data fields. Some data fields may be blank.
2. Use **^** or **v** to move from data field to data field.
3. Press **>** at any data field to show the list of data items that can be displayed there.
4. Highlight the required data item and press **>**. The data item is immediately displayed in that data field.
5. Press **<** or **MENU** when finished and the Data header resizes automatically.

3-3 Setup > Fuel (Explorer 438 only)

These features can be used only when the optional single or twin engine fuel kit has been installed.

Press **MENU** twice to display the **Setup** menu, then select **Fuel**:

Fuel	
Tank full	
Set remaining	0 G
Clear used	
<hr/>	
Tank size	0 G
Num engines	1
Calibrate	
Flow filter	5

WARNING

Northstar fuel kits are only suitable for petrol/gasoline engines. Fuel consumption can change drastically depending upon the boat loading and the sea conditions. Always carry adequate fuel for the journey, plus a reserve.

It is recommended that the fuel tank capacity is measured by draining the fuel tank, then filling it to capacity. After filling, note the reading from the fuel dispenser's gauge.

Note: Beware of air pockets, especially in underfloor tanks.

Tank full

Select **Tank full** each time the fuel tank(s) are completely refilled. When asked **Are you sure?** select **Yes**. Otherwise, the reading on the Fuel display (see section 5-5 Fuel Display) and the Low Fuel Alarm (see section 3-6 Setup > Alarms) are meaningless.

Set remaining

Before doing a partial refill of the tank or removing fuel manually from the tank (for example, by siphoning it off):

1. Note the **Remaining** reading on the Fuel display.
2. Note how much fuel is added or removed.
3. Calculate how much fuel is now in the tank.
4. Select **Set remaining** and update the reading.

It is essential to do this whenever some fuel is added or removed. Otherwise, the reading on the Fuel display (see section 5-5 Fuel Display) and the Low Fuel Alarm (see section 3-6 Setup > Alarms) are meaningless.

3-4 Setup > Data

Press **MENU** twice to display the Setup menu, then select **Data**:

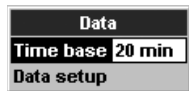

Data setup

To change data items (Explorer 438 only):

1. Select **Data setup**, and press **>**
2. Use **▲** or **▼** to move from data field to data field.

Clear Used

Select **Clear used** to set **Used** (the amount of fuel used) to zero. Do this to start measuring the amount of fuel used over a certain time or distance.

When asked **Are you sure?** select **Yes**.

Tank size

Enter the capacity of the fuel tank.

Num. engines

Select the number of engines to 0, 1 or 2. If 0 is selected the fuel features are turned off.

Calibrate

See section 3-9 Setup > Calibrate.

Flow filter

Most engines do not draw fuel from the tank at a steady rate. To give a stable fuel flow reading, the fishfinder calculates the flow value(s) by taking several measurements and averaging them. Use the Flow filter to set the period over which the fuel flow is averaged.

For twin engine installations, the fuel flow for each engine must be adjusted separately.

The Flow filter can be set from 0 to 10 seconds. Use the lowest value which gives a stable flow. Usually a value of 5 seconds (default setting) will give a satisfactory result for two-stroke carburettor engines.

This setting affects the **Fuel flow** and **Fuel economy** reading on the Fuel display (see section 5-5. Fuel display) but it does not affect the **Fuel used** reading.

3. Press **>** at any data field to show the list of data items that can be displayed there.
4. Highlight the required data item and press **>**. The data item is immediately displayed in that data field.
5. Press **<** or **MENU** when finished.

Time base

To change the Time base of the temperature graph, select **Time base** and press **>**. Choose between 5 mins, 10 mins, 20 mins, 1 hour and 2 hours and press **>** to confirm.

3-5 Setup > Logs

Press **MENU** twice to display the Setup menu, then select Logs:







Logs	
Reset trip dist	
Reset total dist	
Reset engine hours	
Trip dist	0.00 nm
Total dist	0.00 nm
Engine hours	0 hrs

3-6 Setup > Alarms

Press **MENU** twice to display the Setup menu, then select Alarms:

Alarms	
Too shallow	Off
Too deep	Off
Fish	Off
Temperature	Off
Temperature rate	Off
Low battery	Off
Low fuel	Off

Trigger settings can be defined to suit the boat and individual preferences as follows:

c	Alarm Name	Beeper Cycle	Alarm condition is met when the:
	Too shallow	1/3 sec	depth is less than the alarm trigger value
	Too deep	1/2 sec	depth is greater than the alarm trigger value
	Fish	1 short beep	echo matches the fish profile selected by fish filter
	Temp.	1/2 sec	temperature equals the alarm trigger value
	Temp. rate	1/2 sec	rate of change of temperature equals the alarm trigger value
	Low battery	1/2 sec	battery voltage is less than the alarm trigger value
	Low fuel	1/2 sec	fuel remaining equals the alarm trigger value.

The values can be changed independently of each other. These log values are saved when the unit is turned off.

Reset trip dist (Explorer 438 only)

This resets the trip distance to zero.

Reset total dist (Explorer 438 only)

This option resets the total distance to zero.

Reset engine hours

Use this option to reset the engine hours to zero.

This can be useful after an engine service or to count the engine hours between service intervals.

Alarms can be set (enabled) to automatically detect certain conditions, such as the water being too shallow. Alarms that are enabled are shown as black icons in the Alarm status box on the sonar displays.

When an enabled alarm is triggered, the beeper sounds, an alarm message is displayed and the alarm status icon is shown in red.

Press **>** or **MENU** to acknowledge the alarm, stop the beeper and close the alarm window. This does not disable the alarm.

Alarms automatically re-enable

The **Too shallow**, **Too Deep** and **Low battery** alarms automatically re-enable when the value moves outside the alarm trigger setting.

The **Temperature** alarm automatically re-enables when the temperature is more than 0.45°F (0.25°C) above or below the alarm trigger setting.

The **Temperature rate** alarm automatically re-enables when the rate of temperature change falls below the trigger setting by more than 0.2°F (0.1°C) per minute.

Flashing Light and/or External Beeper (Explorer 438 only)

If a secondary alarm indicator is required, a flashing light and/or external beeper can be installed. These can be positioned anywhere suitable on the boat. See section 6-4 Wiring options.

3-7 Setup > Units

Press **MENU** twice to display the Setup menu, then select **Units**:

Units	
Distance	nm
Speed	kn
Depth	ft
Fuel	USGal
Temperature	°F

The default units are shown in this example.

Distance

Select from:

- nm (nautical miles)
- mi (miles)
- km (kilometres)

Speed

Select from:

- kn (knots)
- mph (miles per hour)
- kph (kilometres per hour)

Depth

Select from:

- ft (feet)
- m (metres)
- fa (fathoms)

Fuel

Select from:

- Litres
- USGal (US gallons)
- ImpGal (Imperial Gallons)

Temperature

Select either:

- °F (Fahrenheit)
- °C (Celsius)

3-8 Setup > Comms (Explorer 438 only)

Use this feature when the Explorer 438 is connected to other Northstar instruments or any NMEA compatible instrument.

Press **MENU** twice to display the Setup menu, then select **Comms**:

Comms	
NMEA out	Off
NMEA data	▶

NMEA

NMEA is generally used with third party instruments. Select **On** to transmit NMEA sentences (see Appendix A - Specifications). Otherwise, select **Off**.

NMEA data

Use this to specify which NMEA sentences will be transmitted (see Appendix A - Specifications and section 5-6 Data display, for information about how to display NMEA data).

3-9 Setup > Calibrate

Press **MENU** twice to display the Setup menu, then select **Calibrate**:

Calibrate	
Speed	
Speed filter	Off
Temperature	
Temp filter	5
Fuel	
Keel offset	0.0 ft

The fuel options can be calibrated only when the optional single or twin engine kit is installed on petrol/gasoline engines.

Speed

Calibration may

be required because different hull shapes have different flow characteristics.

Obtain an accurate measurement of the boat's speed from a GPS receiver; or by following

another boat travelling at a known speed; or by making a timed run over a known distance.

Note: for accurate calibration:

- The speed from a GPS receiver should be greater than 5 knots.
- The speed from another paddlewheel transducer should be between 5 and 20 knots.
- Best results are achieved in calm conditions where there is minimal current (best at high or low tide).

Use the cursor keys to display the speed readout box, then increase or decrease the readout to match the independent speed value.

Temperature

The factory settings should be sufficiently accurate for normal usage. To calibrate the temperature readout, first measure the water temperature with a thermometer known to be accurate.

Use the cursor keys to display the temperature readout box, then increase or decrease the value to match the measured temperature. The temperature can be set from 32° to 99.9°F (0° to 37.7°C) with a resolution of 0.1° unit.

To change the units between °F (Fahrenheit) or °C (Celsius), see section 3-7 Setup > Units.

Fuel

Calibrating the fuel usage can improve the accuracy of fuel measurements.

Twin engine installations require each fuel transducer to be calibrated. This can be done at the same time with two portable tanks or at different times using one portable tank.

Calibrating the fuel transducer(s) requires accurate measurement of the fuel consumption. This is best done using a small portable tank. At least 4 gallons (15 litres) of fuel should be used to ensure an accurate calibration.

It is often very difficult to fill underfloor tanks to the same level twice due to air pockets, so the more fuel used, the more accurate the calibration.

To calibrate the fuel transducer(s), perform the following steps:

1. Record the level of the fuel in the tank(s).
2. Connect the portable tank(s) to the engine through the fuel transducer(s).
3. Run the engine at normal cruising speed until at least 4 gallons (15 litres) of fuel has been used per engine.

4. Check the actual amount of fuel used per engine by refilling the portable tank(s) to the original level and noting the reading(s) from the fuel dispenser's gauge.
5. Select **Fuel**. Use **Λ** or **V** to change the reading to match that on the fuel dispenser's gauge.
6. Press **>** when the reading is correct.

Note: If the fuel calibration options appear to give erroneous readings after a while, first check that the fuel sensor has been installed correctly according to the installation instructions supplied with it, then see Appendix B - Troubleshooting.

Keel Offset

Keel offset is a depth correction representing the vertical distance between the depth transducer and the location from which the depth is to be measured.

Enter a **positive** keel offset value when the transducer is located below the water surface but the total depth is required.

Enter a **negative** keel offset value when the depth below the deepest part of the boat is required (such as the keel, the rudder or the propeller) and the transducer is located closer to the water surface.

Use the cursor keys to select **Keel offset**, then press **>** to display the Keel offset box.

Use the **Λ** or **V** cursor keys to adjust the value.

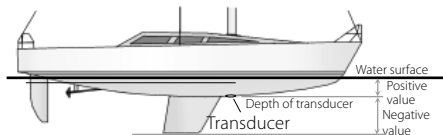

Note: Boat illustrated uses a through hull transducer

4 Using the Explorer 435 and Explorer 438

This section explains how to interpret the sonar displays and how fish are detected and displayed. It also describes Gain and Range and shows

4-1 Interpreting the display

The sonar displays do not show a fixed distance travelled by the boat; rather, they display a history, showing what has passed below the boat during a certain period of time.

The history of the sonar signal displayed depends

examples of some of the different sonar displays. Also see section 1-2 How the Explorer 435 and Explorer 438 works.

the depth of the water and the scroll speed setting.

In shallow water, the echoes have a short distance to travel between the bottom and the boat. In deep water, the history moves across the display

more slowly because the echoes take longer to travel between the bottom and the boat. For example, when the scroll speed is set to Fast, at depths over 600 ft (180 m) it takes about 2 minutes for each vertical line of pixels to move across the display, whereas at 20 ft (6 m) it takes only about 25 seconds.

The scroll speed can be set by the user to display either a longer history with less fish information or a shorter history with more fish details. See section 3-2 Setup > Sonar.

If the boat is anchored, the echoes all come from the same area of bottom. This produces a flat bottom trace on the display.

The screen shot shows a typical sonar display with the Fish symbols turned Off.

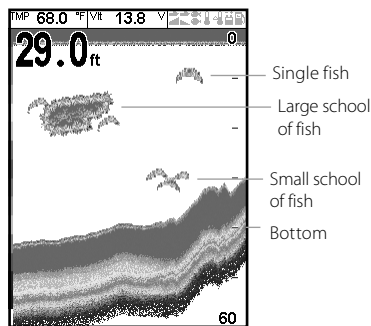

- Size of the fish, school of fish or other object.
- Depth of the fish or object.
- Location of the fish or object. (The area covered by the ultrasonic pulse is a rough cone shape and the echoes are strongest in the middle.)
- Clarity of water. Particles or air in the water reduce the strength of the echo.
- Composition or density of the object or bottom.

Note: Planing hulls at speed produce air bubbles and turbulent water that bombard the transducer. The resulting ultrasonic noise may be picked up by the transducer and obscure the real echoes.

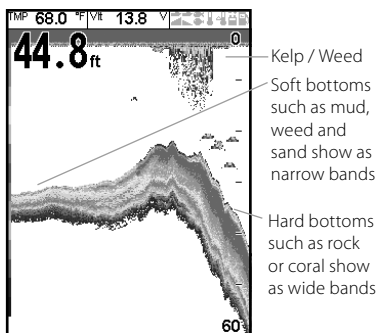

Bottom types

Mud, weed and sandy bottoms tend to weaken and scatter the sonar pulse, resulting in a weak echo. Hard, rocky or coral bottoms reflect the pulse, resulting in a strong echo. See section 5-3 Sonar Bottom display.

Strength of echoes

The colors indicate differences in the strength of the echo. The strength varies with several factors, such as the:

Frequency and cone width

The pulse generated by the Explorer 435 and Explorer 438 transducer travels down through the water, spreading outwards to form a rough cone shape. Inside the cone, the return signals are the strongest. The cone width is dependent upon the transducer design and the frequency of the pulse: with Northstar's transom mount supplied, it is about 15°. The chart shows how the cone width varies over depth for each frequency used. Figures are approximate.

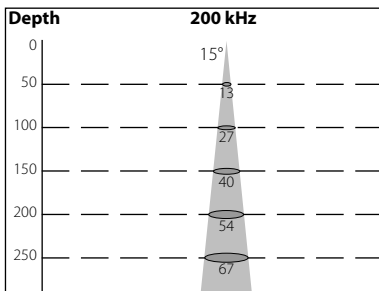

Shadows

Shadows are created around areas where the ultrasonic beam cannot 'see'. These areas include hollows on the bottom or beside rocks and ledges, where the strong echoes returned off the rocks obscure the weak echoes of the fish and may also create a double bottom trace. See following for an example of the sonar display in such an environment. A double bottom trace is shown on the display.

Example of shadows

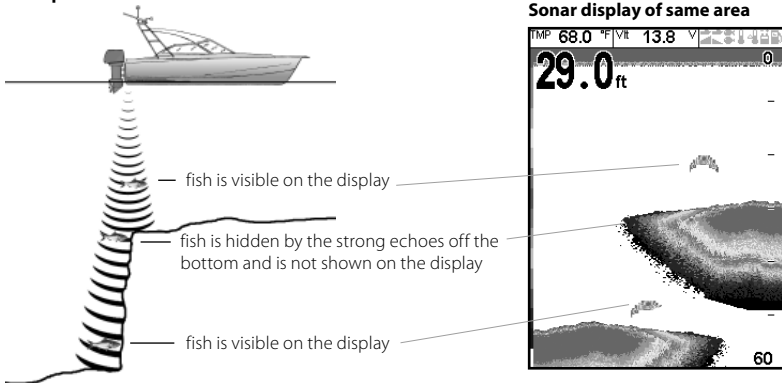

Northstar fishfinders display the most recent events on the right of the screen.

Moving boat

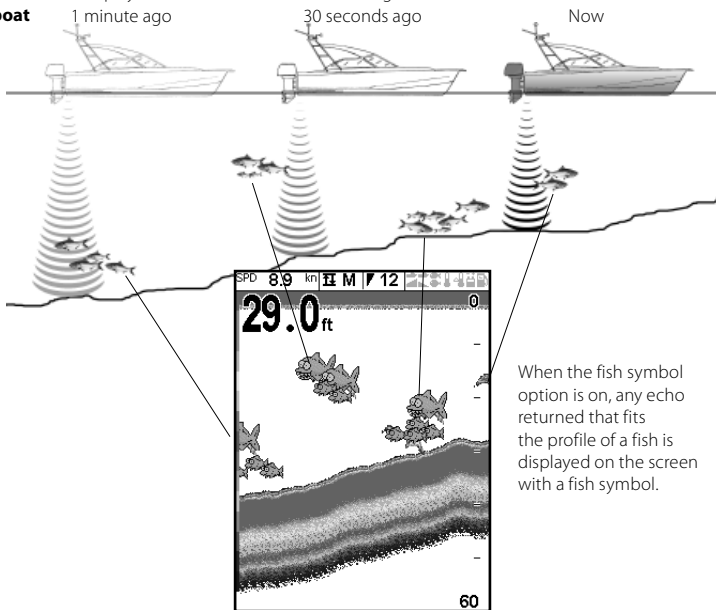

Stationary boat

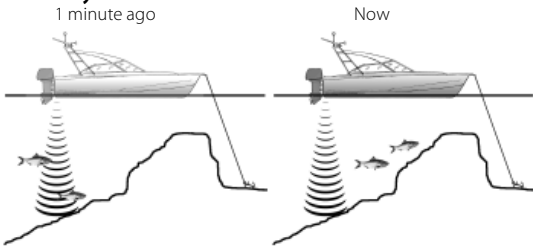

When a boat is stationary, all bottom echoes will come from the same small area of bottom. This will produce a flat bottom trace on the screen.

The appearance of the Sonar and Zoom screens can be changed to suit individual preferences.

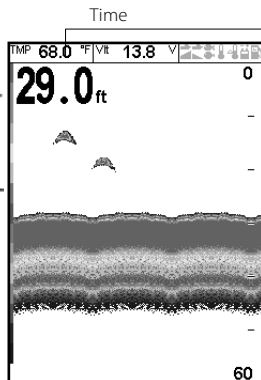

Note: Times indicated are for illustration only.

4-2 Fish detection and display

Where to find fish

Underwater features like reefs, wrecks and rocky outcrops attract fish. Use the sonar to find these features, then look for fish by passing over the feature slowly several times using the Zoom display (see section 5-2 Sonar Zoom display). If there is a current, the fish will often be found downstream of the feature.

When fishing with the Explorer 435 and Explorer 438 with the Fish symbols OFE , a weak fuzzy band may appear between the bottom trace and surface. This might indicate a thermocline - a rapid change in water temperature, such as the edge of a warm or cold current. The temperature difference can form a barrier which the fish may not swim through. In fresh water, fish often collect around a thermocline.

Fish symbols

The fish symbol can be customized or switched off altogether so that the echoes are not converted to fish symbols on the display. See section 3-2 Setup > Sonar. The differences between Fish symbol $\text{On} + \text{dept:h}$ and OFE are:

Fish symbols On

Using Northstar's SBN sonar technology the fishfinder analyses all echoes and eliminates most false signals and clutter so that remaining targets are most likely fish. Depending on the strength of

the remaining echoes, they are displayed as either small, medium or large fish symbols - with or without depth. While the SBN processing is very sophisticated it is not

foolproof - there will be times when the fishfinder will not be able to differentiate between large air bubbles, rubbish containing air, fishing floats etc. and fish.

The following picture shows the Sonar display with the Fish symbol: $\text{On} + \text{dept:h}$:

Fish symbol Off

For experienced users this always provides the best information as every echo is displayed, whether it is surface clutter, a thermocline or a fish.

The picture in section 4-1 Interpreting the display, shows the Sonar display with the Fish symbols OFE . The fish appear as arches.

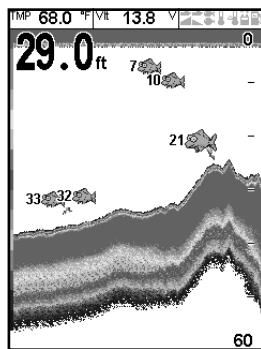

Fish arches

In good conditions and with Fish symbols OEF , a fish passing through the cone-shaped ultrasonic pulse is displayed as a fish arch.

A fish arch occurs when a fish enters the weak edge of the sonar cone, generating a weak echo that is displayed as the first pixel of the fish arch. As the fish moves closer to the middle of the cone, the distance between the transducer and the fish reduces and the echo is displayed at progressively shallower depths, producing the start of an arch. When the fish passes directly beneath the middle of the cone, the echo becomes strongest and thickest. As the fish passes out of the middle of the cone the reverse happens with a progressively weaker and deeper echo.

There are many reasons why fish arches may not be seen. For example:

- Poor transducer installation (see *Transom*

4-3 Gain

Gain (sensitivity) controls the amount of detail displayed on the Explorer 435 and Explorer 438. Understanding how to set suitable Gain settings is important for optimum performance.

The Northstar fishfinder has two gain modes, Auto Gain and Manual Gain. Normally the best results are obtained in Manual Gain, but practice and experience are required to obtain the optimum settings for different conditions. Therefore, the use of Auto Gain is strongly recommended when learning to use the fishfinder or when travelling at speed.

- In Auto Gain, the gain adjusts automatically to compensate for water depth and clarity.
- In Manual Gain, the gain can be adjusted by the user to compensate for water depth and clarity.

High Gain settings may amplify the normal background noise until it appears as random pixels.

Changing between Auto and Manual

To change between Auto Gain and Manual Gain:

1. From any Sonar display, press O .
2. Use the > cursor key to select **Auto** or **Manual**.

Adjusting Gain settings

1. From any Sonar display, press O .
2. Use the ^ or v cursor keys to change the gain.

Transducers Installation Guide).

- If the boat is anchored then fish will tend to show on the display as horizontal lines as they swim into and out of the transducer sonar beam. Slow speeds in deeper water give the best fish arch returns.
- Range is important. It will be much easier to see fish arches when using zoom mode to concentrate on a particular section of water, rather than just displaying everything from the surface to the bottom. Zooming increases screen resolution up to 100 times.
- It is difficult to get fish arches in shallow water as the transducer sonar beam is very narrow near the surface and fish do not stay within the beam long enough to display an arch. Several fish in shallow water tend to display as randomly stacked blocks of pixels.
- Wave motion may result in distorted fish arches.

Note: The Gain mode automatically changes to Manual Gain if the gain setting is adjusted by the user.

Obtaining the best results

To obtain the best detection capability for both fish and bottom

we recommend the user adjusts the gain in the A-Scope display until the threshold line is just to the right of the unwanted noise:

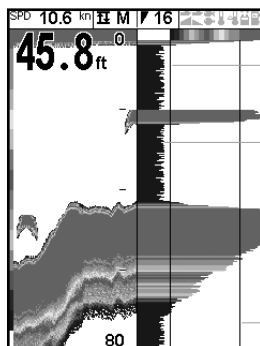
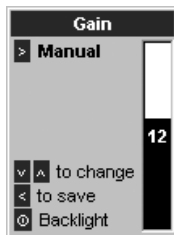

4-4 Range

Range is the vertical depth displayed on the Explorer 435 and Explorer 438.

The Northstar fishfinder has two range modes, Auto Range and Manual Range:

- In Auto Range, the fishfinder adjusts the depth range automatically so the bottom is always shown in the lower part of the display. The use of Auto Range is recommended for normal conditions.
- In Manual Range, the fishfinder shows only a selected depth range. In areas of rapidly changing bottom depth, such as the sea floor around pinnacles, it can be useful to prevent the display from rescaling to always show the bottom. If the bottom is deeper than the specified depth range, it will not be shown on the display.

Changing the Range Mode

To change between Auto Range and Manual Range, hold the **+** or **-**. The Range mode is displayed at the bottom of the screen.

Press the **+** or **-** key to change to increase or decrease the range to the desired depth. Values can be set between 10 ft (3 m) to 600 ft (180 m).

Zoom Range and Zoom Offset

On the Sonar Zoom and Sonar Bottom displays, a vertical bar is shown on the far right of the display. This is the zoom bar. The zoom bar shows the zoom range; that is, the area that is magnified.

Use the **<** or **>** cursor keys to adjust the zoom range.

Use the **Λ** or **V** cursor keys to adjust the zoom offset.

5 The Displays

Press **MENU** once to show the Display menu, then select a particular display using the **Λ** or **V** cursor keys then press **>** to confirm. (Section 2 Basic Operation, describes how to use the keys in more detail.)

The Display menu is summarized here and each display is shown in the following sections.

Most displays have an Options menu so that relevant features can be changed quickly.

The Display menu

Display	
Sonar	Full screen display of Sonar history (section 5-1)
Sonar Zoom	Split display with Sonar and zoomed section (section 5-2)
Sonar Bottom	Bottom trace displayed as flat line in zoomed section (section 5-3)
Sonar A-Scope	Split display with Sonar and echo strength (section 5-4)
Fuel	Fuel data (section 5-5)
Data	Water temperature, depth history and other boat data (section 5-6)
Split ratio 0%	See below.
MENU for setup	

Split Ratio

Use this to change the split ratio between the zoom and the sonar history sections displayed. The default split ratio is 50%.

1. Highlight **Split Ratio** and press **>**.
A left arrow and right arrow appear on either side of the divider line.
2. Use the **<** or **>** cursor keys to adjust

Hint: Press **<** to return to the last sonar display used. Press **MENU** then **>** to return to the previously selected display. Use this to switch between two frequently used displays.

Refer to Section 3-2 Setup > Sonar, for information about customizing features on the sonar displays.

5-1 Sonar display

To show the Sonar display highlight **Sonar** and press **>**:

This display scrolls from right (most recent echoes) to left (oldest echoes). (see section 3-2 Setup > Sonar).

Data header, set up to show the water temperature, battery voltage (See section 3-2 Setup > Sonar)

Depth (medium size digits)

Color bar

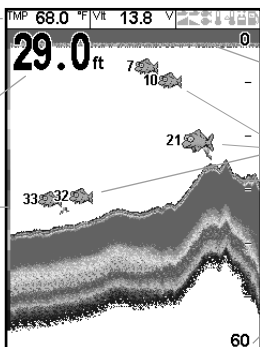

Surface

Fish symbols with depth

Bottom

Range

5-2 Sonar Zoom display

To show the Sonar Zoom display, highlight **Sonar Zoom** and press **>**:

The split display shows the sonar history on the right side and the zoom section on the left.

The zoom bar on the far right shows the area that is magnified in the zoom section. See section 4-4 Range, for information about adjusting the Zoom Range and Zoom Offset.

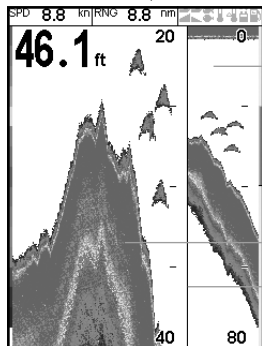

Sonar history

Zoom bar

Zoom section

Divider line

5-3 Sonar Bottom display

To show the Sonar Bottom display, highlight **Sonar Bottom** and press **>**.

This shows a split display, with the sonar history on the right side and the zoom section on the left. The bottom signal is shown as a flat trace in the centre of the zoom section.

Showing the bottom as a flat trace can make it easy to compare the echo strengths shown in the

bottom signals. This can help to identify the type of bottom and objects close to the bottom.

The zoom bar can only indicate the zoom range. It cannot indicate the zoom offset as this changes for each sounding displayed on the display. The zoom bar is fixed in the middle of the display.

See section 4-4 Range, for information about adjusting the Zoom Range and Zoom Offset.

5-4 Sonar A-Scope display

To show the A-Scope display, select **Sonar A-Scope** and press **>**. Use this to analyse the sonar data in detail and optimize the Gain settings.

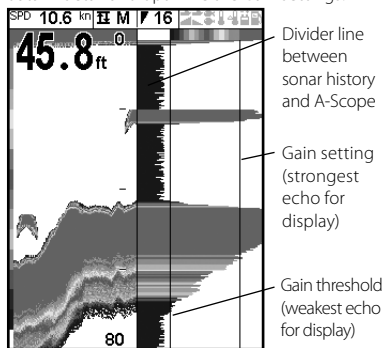

The user can define the level of the weakest and strongest echoes to be shown on the sonar displays, by using the Gain setting. See section 4-3 Gain, for more information.

The strength of an echo at a particular depth is shown by the length of the horizontal line at that depth. A strong echo produces a long line whereas a weak echo produces a short line.

Fish recognition

The echo strengths shown on the A-Scope can be useful in recognising the type of fish. Different species of fish have different sizes and shapes of swim bladders. The air in the swim bladder reflects the ultrasonic pulse, so the strength of the echo varies between fish species according to the size and shape of the swim bladder.

When fishing among a school of fish and catching them, note the fish species and the strength of the echo that it returns on the A-Scope. Then, when that particular echo is seen at future times on the fishfinder, it is likely to be the same fish species.

5-5 Fuel display (Explorer 438 only)



To show the Fuel display, select **Fuel** and press **>**.

(See section 3-3 Setup > Fuel for information about setting up the fuel values. If the number of engines is set to 0, the fuel features are turned off.)

Used shows total fuel used since this was last reset with the **Clear Used** command.

Remaining shows the amount of fuel remaining in the tank(s).

Flow shows the fuel consumption per hour. For twin engine installations, the fuel flow for each engine is shown separately. This is useful for checking that both engines are under the same load.

Economy is the distance travelled per unit of fuel used. The fishfinder calculates this from the boat speed and fuel used. The bigger this number, the better the fuel economy. Adjust the throttle and trim to achieve the best fuel economy. Note that the Explorer 438 uses a paddlewheel transducer to measure speed, used to calculate the fuel economy. Therefore, calibration of the boat speed measurement is essential for an accurate fuel economy reading. See section 3-8 Setup > Calibrate.

5-6 Data display

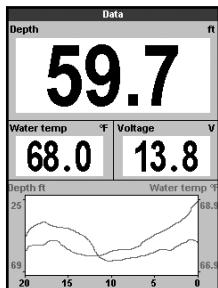

To show the Data display, select **Data** and press **>**. The data display shows a graph of the water temperature and depth over time and other selected data items.

The graph is useful for locating warm and cold spots in the water.

Refer to section 3-4 Setup > Data to change the displayed data items and temperature graph time base. To change units, refer to section 3-7 Setup > Units.

time base
(Select from 5 minutes to 2 hours)

6 Installation and Maintenance

Correct installation is critical to the performance of the Explorer 435 and Explorer 438. There are two components to install, the display unit and the transducer. It is vital to read the entire installation section of this manual before attempting to install the components.

6-1 What comes with this product?

Standard configuration:

- Explorer 435 or Explorer 438 display unit
- Power cable*
- Mounting bracket (screws included)
- Warranty registration card
- This manual
- Sun cover for display unit
- Flush mounting kit*
- Transom transducer (includes cable kit and screws)
- Transom Mount Transducer Installation Manual.

* denotes Explorer 438 only.

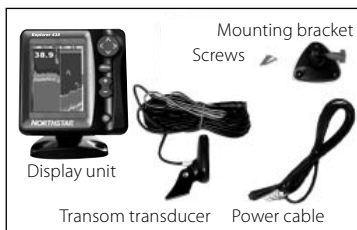

6-2 Options and Accessories

- Explorer 500 series chartplotters
- Through hull depth transducer
- Through hull speed/temperature transducer*
- Fuel flow kit (single or twin engine)*
- Replacement paddle wheel*
- Carry bag
- Explorer R310 (see section 6-5 Systems of several instruments).

Please consult your Northstar dealer for more information.

* denotes Explorer 438 only



6-3 Mounting and removing the display unit

There are two mounting arrangements:

- **Flush mounting** requires a solid panel with access behind for wiring and mounting screws. After flush mounting, the Explorer 435

and Explorer 438 cannot be tilted or moved after installation to reduce any unwanted glare or reflections. Carefully select the best viewing position before installation. This would generally be in a shaded area.

- **Bracket mounting** requires a panel for mounting the bracket. Ensure that the panel is not likely to deform and is not subject to excessive vibration. The bracket can be tilted and rotated so the Explorer 435 and Explorer 438 can be removed after each use.

Select a position where the display unit will be:

- At least 4" (100 mm) away from the compass.
- At least 12" (300 mm) away from any radio transmitter.
- At least 4 ft (1.2 m) away from any antenna.
- Easy to read by the helmsman and crew while underway.
- Protected from physical damage during rough sea passages.
- Easy to access the 12 V DC power source.
- Convenient to route the transducer cables.

Flush Mounting

1. Cut a hole in the bulkhead for the display unit using the flush mount template.
2. Drill four holes for the mounting studs using the flush mount template.

6-4 Wiring Options

The power/data cable contains 5 wires:

Wire Function

Black	Ground (power negative)
White*	NMEA out
Red	Positive power in, 12 V DC
Yellow	Auto power in (connect to red wire. Positive power in, to enable Auto power).
Green*	External beeper or light out, switched to ground, 30 V DC 200 mA maximum.

Note: The cable shield is connected to Pin 1 (black wire) and does not need to be grounded. * Denotes Explorer 438 only.

CAUTION

1 Amp fuses must be positioned where shown in the wiring diagrams.

Basic wiring

This requires the Explorer 435 and Explorer 438 to be powered on manually with the  key.

Black wire: Connect this to the negative battery terminal.

3. Screw the four studs into the brass inserts in the back of the display unit.
4. Sit the display unit in place and fit the washers and nuts to the studs.

Bracket Mounting

1. Fix the mounting bracket onto the boat using the three stainless steel screws. Do not overtighten the screws, as the bracket may not rotate.
2. Push the display unit onto the mounting bracket and tighten it firmly using the knob on the mounting bracket.
3. Attach the cables.

Removing the display unit

The display unit can be removed after each use for protection against the environment or security reasons.

When removing the display unit, ensure that the plugs left in the boat are not exposed to the elements. Push the attached dust covers over the exposed ends of the plugs. Keep the display unit in a dry clean place such as the optional Northstar carry bag.

Six wiring options are described in this section:

- **Basic wiring.** This does not start the fishfinder automatically when the boat ignition is switched on and it disables the engine hours counter.
- **Auto power wiring.** This must be used for the engine hours and fuel computer options.
- **Secondary Alarm wiring**
- **NMEA wiring**
- **Single engine fuel wiring**
- **Twin engine fuel wiring**

Note: If a wire color is not specifically mentioned, it is not used in that wiring option.

Section 6-5 Systems of several instruments, describes NMEA and NavBus.

Red wire: Connect this to the positive battery terminal after the main switch. Fit a 1 Amp fuse as shown.

Yellow wire: Connect this to the black wire. This disables the engine hours counter.

Power on the fishfinder manually whenever the main switch is on.

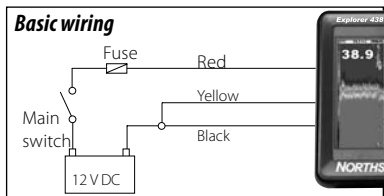

NMEA wiring Option (Explorer 438 only)

White Wire: Use this, if desired, to connect the fishfinder to other NMEA instruments such as Northstar's Explorer R310. (See section 6-5 Systems of several instruments.)

Secondary alarm wiring option (Explorer 438 only)

Green Wire: Use this to connect a secondary alarm indicator such as a flashing light or external beeper with a built-in drive circuit. See the Auto power wiring diagram.

If the external beeper or light requires more than 200 mA total, fit a relay. Consult your Northstar dealer for more advice.

Fuel kit wiring (Explorer 438 only)

See the *Fuel Kit Installation Guide* for information about the fuel transducer cable.

Wire the power cable for Auto power (as described in this section) to make sure the fuel counter starts as soon as the engine starts.

For twin engine installation, a T-connector needs to be installed on the fuel transducer cable.

Auto power option

Black wire: Connect this to the negative battery terminal.

Red wire: Connect this to the positive battery terminal after the main switch. Fit a 1 Amp fuse as shown.

Yellow wire: To enable the engine hours counter and fuel counter; and to start the fishfinder automatically when the ignition is turned on, connect the yellow wire to the ignition system through a 1 Amp fuse.

Note: *The fishfinder cannot be turned off while the ignition is on.*

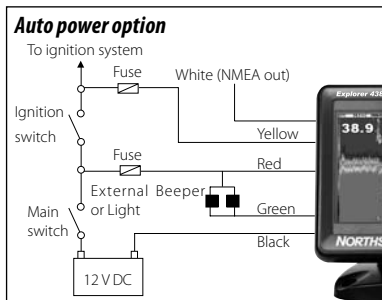

Through hull transducers

Through hull transducers are supplied with 'Y' adapter cable for connection of both transducers into top socket with blue nut.

Speed/Temperature through hull transducer

Through hull depth transducer

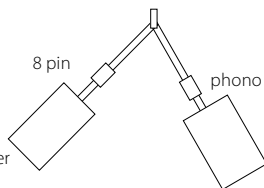

6-5 Systems of several instruments

Several Northstar instruments can be connected together to share data.

NMEA

NMEA is an industry standard for marine instrument connections. Data sent by one instrument over an NMEA line can be read and

displayed by another instrument that accepts NMEA 0183 Version 2. It requires dedicated connections between instruments.

Please contact your Northstar dealer for information on Northstar's full range of NMEA enabled instruments and connection options.

Explorer R310: Repeater for depth, speed, water temperature and battery voltage. Accepts NavBus or NMEA data inputs from other instruments.



Explorer D210:
Depth Repeater



Explorer 550:
Color GPS
Chartplotter
with worldwide
coverage



6-6 Cleaning and maintenance

Clean the screen **only** with a damp cloth and mild detergent when dirty or covered in sea salt. Avoid abrasive cleaners, petrol or other solvents.

Cover or remove a transom-mounted transducer when repainting the hull. If painting over a through hull transducer with antifouling paint, use only one coat of paint. Remove the previous coat of antifouling paint by sanding it lightly. To optimize performance, avoid walking on or jamming cables

and connectors. Keep the transducer free of weed, paint and debris. Do not use a high pressure water blast on a speed sensor paddlewheel as it may damage the bearings.

When not in use, the Explorer 435 or Explorer 438 can be removed from the installation bracket and stored in the Northstar carry bag, or left on the installation bracket and securely covered with the sun cover.

Appendix A - Specifications

Depth range

- 2 ft (0.6 m) to 600 ft (180 m).

Display type

- TFT Color.
- Screen resolution 320 high x 240 wide (pixels).
- LED multi-level backlighting.

Supply voltage

- 10 to 16 V DC.

Supply current at 13.8 V

- 300 mA min - no backlighting.
- 400 mA max - full backlighting.

Output power

- Variable, up to 200 W RMS.

Operating temperature

- 32° to 122°F (0° to 50°C)

Transom transducer cable length

- Explorer 435 33 ft (10 m).
- Explorer 438 26 ft (8 m).

Typical depth acquisition time from startup

- 2 seconds at 100 ft (30 m).

Receiver sensitivity

- Better than 10 micro volts RMS.
- Dynamic range 4.0 million to 1 (120 dB).

Temperature measurement range

- 32° to 99.9°F (0° to 37.7°C)
Resolution of 0.1° unit.

Transducer frequency

- 200 kHz.

Speed range

- 1 to 50 kn (57.5 mph, 96.6 kph).

Standards Compliance

- EMC: USA FCC Part 15 Class B.
Europe (CE) EN50081-1 and EN50082-1
New Zealand and Australia (C Tick)
AS-NZS 3548.
- Environment: IPx6, IPx7.

NMEA Output (Explorer 438 only)

NMEA 0183 (Ver 2.0) 4800 baud is a standard for interfacing marine electronic devices. The Northstar fishfinder can output the following sentences:

- DBT (Depth Below Transducer)
- DPT (Depth and Keel offset)
- MTW (Water temperature)
- XDR (Battery voltage and fuel flow).
- VHW (Speed)

Fuel Computer (Explorer 438 only)

(optional fuel transducer(s) required)

- Outboard carburetted two stroke and EFI petrol/gasoline engines: 30 to 300 hp.
- Outboard four stroke petrol/gasoline engines: 90 to 300 hp.
- Inboard petrol/gasoline engines: 50 to 300 hp.
- Minimum flow rate: 1.3 U.S. gallons per hour (5 litres per hour).
- Maximum flow rate: 34 U.S. gallons per hour (130 litres per hour).

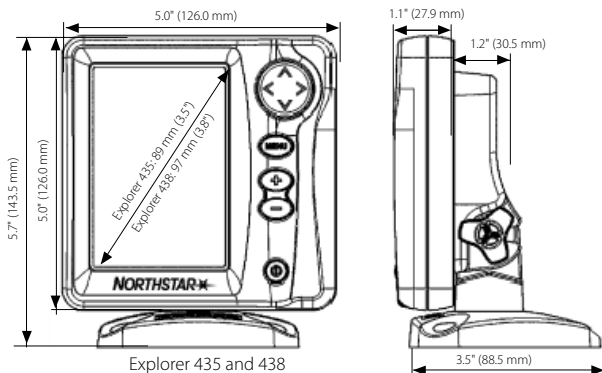

Explorer 435 and 438

Appendix B - Troubleshooting

This troubleshooting guide is written with the assumption that the user has read and understood the relevant sections in this manual.

It is possible in many cases to solve difficulties without having to send the display unit back to the manufacturer for repair. Please follow this troubleshooting section before contacting the nearest Northstar dealer.

There are no user serviceable parts. Specialized methods and testing equipment are required to ensure that the display unit is reassembled correctly and is waterproof. Users who service the product themselves will void the warranty.

Repairs to the product may only be carried out by a service centre approved by Northstar. If the product must be sent into a service centre for repair, it is essential to send in the transducer(s) at the same time.

More information can be found on our Website: www.Northstarnav.com.

1. The fishfinder won't turn on:
 - a) The Explorer 435 and Explorer 438 are designed to operate on a 12 volt battery system, where the voltage may vary from 10 to 16.5 volts. If an excessive voltage is supplied, a resettable fuse will be tripped, turning the display unit off.
 - b) Check that the power cable connector at the back of the display unit is securely plugged in and the collar is locked in place. The collar must be secure for watertight connection.

- c) Measure the battery voltage while the battery is under load - turn on some lights, radio or other electrical equipment connected to the battery. If the voltage is less than 10 volts:
 - the battery terminals or wiring on the terminals may be corroded.
 - the battery may not be charging correctly or may need replacing.
 - d) Inspect the power cable from end to end for damage such as cuts, breaks, squashed or trapped sections.
 - e) Ensure that the red wire is connected to the positive battery terminal and the black wire to the negative battery terminal. If wired for the Auto Power option, ensure the yellow wire is connected to the ignition circuit. Also check the boat's main switch circuit (see section 6-5 Wiring options).
 - f) Check for corrosion on the power cable connector and clean or replace if required.
 - g) Check fuses that are placed in line with the power cable. A fuse can be blown despite appearing to be good or the fuse may be corroded. Test the fuse or replace it with a fuse known to be good.
2. The fishfinder won't turn off:

The fishfinder may have been wired for Auto power. In this case, the fishfinder cannot be turned off while the ignition power is on. (See Auto power wiring in section 6-4 Wiring options.)

3. The fishfinder operates erratically:
 - a) Check that the transducer does not have debris (e.g. weed, plastic bag) caught around it.
 - b) The transducer may have been damaged during launching, running aground or while underway with debris etc. If the transducer has been impacted, it may have been kicked up on the bracket. If it is not physically damaged, reset the transducer back to its original position. (See the *Transom Transducer Installation Guide*.)
 - c) When the transducer is less than 2 ft (0.6 m) from the bottom, the depth readings may become inconsistent and erratic.
 - d) Manual Gain may be set too low, which may cause weak bottom echo or no fish signals. If in Manual Gain, try increasing the Gain.
 - e) Ensure the back of the bottom surface of the transducer is slightly lower than the front and the front is as deep in the water as possible in order to minimize the generation of bubbles through cavitation. (See the *Transom Transducers Installation Guide*.)
 - f) Check the transducer and power cable connectors at the back of the display unit are securely plugged in and the collars are locked in place. The collars must be secure for watertight connection.
 - g) Inspect the power cable from end to end for damage such as cuts, breaks, squashed or trapped sections.
 - h) Ensure there is not another fishfinder or depth sounder turned on, which may interfere with this fishfinder.
 - i) Electrical noise from the boat's engine or an accessory may be interfering with the transducer(s) and/or the Northstar fishfinder. This may cause the fishfinder to automatically decrease the Gain unless using Manual Gain. The fishfinder thus eliminates weaker signals such as fish or even the bottom from the display. This may be checked by switching off other instruments, accessories (e.g. bilge pump) and the motor until the offending device is located. To stop problems from electrical noise, try:
 - re-routing the power and transducer cable(s) away from the boat's other electrical wiring.
 - routing the display unit's power cable directly to the battery with an in-line fuse.
4. Bottom is not displayed:
 - a) The fishfinder may have Manual Range selected and the depth may be outside the range value selected. Either change the fishfinder to Auto Range or select another depth range (see section 4-4 Range).
 - b) The depth may be outside the fishfinder's range. While in Auto Range, the display unit will display "--." to indicate that there is no bottom detected. A display of the bottom should reappear when in shallower water.
5. The bottom is displayed too far up the screen:

The fishfinder may have Manual Range selected and the selected Range value is too high for the depth. Either change the fishfinder to Auto Range or select another depth range (see section 4-4 Range).
6. Bottom echo disappears or erratic digital reading while the boat is moving:
 - a) Ensure the back of the bottom surface of the transducer is slightly lower than the front and the front is as deep in the water as possible in order to minimize the generation of bubbles through cavitation. (See the *Transom Transducers Installation Guide*, for more information.)
 - b) The transducer may be in turbulent water. Air bubbles in the water disrupt the echoes returned, interfering with the fishfinder's ability to find the bottom or other targets. This often happens when the boat is reversed. The transducer must be mounted in a smooth flow of water in order for the fishfinder to work at all boat speeds.
 - c) Electrical noise from the boat's motor can interfere with the fishfinder. Try some suppression spark plugs.
7. If the fishfinder beeps when turned on but nothing is displayed:

The fishfinder may be operating, but the backlight settings may have been set too low. See section 2 Basic Operation, to adjust the fishfinder backlight. (Press **1** twice)
8. The wrong language is displayed:

See section 3-1 Setup > System.

9. Fuel used or remaining seem inaccurate:

- a) If the engine is run while the fishfinder is powered off, the fishfinder does not record the amount of fuel used during that engine run. Consequently, the Fuel remaining value will be higher than the actual amount of fuel remaining in the tank.

To avoid this problem, use the Auto Power Wiring option described in section 6-4 Wiring options. This ensures that the fishfinder powers on automatically whenever the boat's ignition is switched on.

- b) In rough seas, fuel may surge back and forth through the fuel transducer, resulting in incorrect readings. Try installing a one-way valve between the fuel transducer and the fuel tank.
- c) The Set remaining fuel value must be reset after every refuelling (see section 3-3 Setup > Fuel).
- d) The fuel tank may not refill to the same capacity each time due to air pockets. This is particularly noticeable with underfloor tanks.
- e) Fuel transducers wear out over time and should be replaced after every 5000 litres of fuel.

10. Flow indicates no fuel or low fuel:

- a) Check that the number of engines is set to 1. See section 3-3 Setup > Fuel.
- b) Check that the fuel cable connectors are securely plugged in and the collar is locked in place. The collar must be locked in place to give a watertight connection.
- c) A fuel transducer may be clogged. If so, remove the transducer from the fuel line and gently blow through it in the opposite direction to the fuel flow.

A fuel filter between the fuel transducer and the fuel tank must be installed as per the fuel installation guide. Failure to do so will void the warranty.

d) Inspect the fuel cable from end to end for damage such as cuts, breaks, trapped or squashed sections.

e) Check that the fuel filter is clean.

11. A twin engine installation shows only one flow rate:

a) Check that the number of engines is set to 2. See section 3-3 Setup > Fuel.

12. Erratic Fuel Flow readings:

a) The fuel flow transducer may have been mounted too close to the fuel pump or may be subject to excessive vibration. Refer to the installation instructions supplied with the fuel transducer.

b) Check for leaks in the fuel line or in the fuel pickup in the tank.

c) The Flow filter value is not suitable for the engine. Check that the value is not set to zero, then try increasing the value until a steady flow rate is shown. See section 3-3 Setup > Fuel.

13. There is no reading for fuel economy:

a) The boat must be travelling through the water to generate an Economy reading.

b) Check that the paddlewheel on the transducer is spinning freely and that the two magnets in the paddlewheel are still in place.

14. There is a double bottom trace displayed:

a) The boat may be in an area that generates shadows. See section 4-1 Interpreting the display.

b) In shallow water, the echoes may bounce. Reduce the gain setting (see section 4-3 Gain).

c) Decrease the Range.

AMERICAS

30 Sudbury Road,
Acton, MA 01720, USA
Ph: +1 978.897.6600
Ph: +1 800.628.4487
Fax: +1 978.897.7241
sales@bntmarine.com

EUROPE

Unit 2, Ocean Quay,
Belvidere Rd, Southampton,
SO14 5QY, ENGLAND
Ph: +44 2380 339922
Fax: +44 2380 330345
northstaruk@northstarnav.com

AUSTRALIA

PO Box 479,
Gladesville, NSW 2111,
AUSTRALIA
Ph: +61 2 9879 9060
Fax: +61 2 9879 9009
northstaraus@northstarnav.com

NEW ZEALAND

PO Box 68 155,
Newton, Auckland
Auckland, NEW ZEALAND
Ph: +64 9 481 0500
Fax: +64 9 481 0590
northstarnz@northstarnav.com

www.northstarnav.com

NORTHSTAR 



Made in New Zealand
MN000598A-G